

**PROFILE
CATALOGUE
2021 / 2022**

**LIGHT UP YOUR
WORLD**

LigLED[®]

Trusted Eco Lighting Solution

**PROFESSIONAL
LIGHTING SOLUTION**



CONTENTS

02

Company Profile

About LigLED and its mission and vision

04

Production Facilities

About our proprietary hardware that fuels our LEDs

05

Research & Development

Focused on better products for better user experiences

06

Certifications & Awards

Accomplishments and certifications that ensure the quality of our products

07

Project References

Completed projects with trust and lasting relationships

08

Indoor & Commercial Lighting

The key feature of any interior design

35

Industrial Lighting

Built to last in the toughest situation

41

Outdoor Lighting

Brighten any outdoor space or give key accents

47

Landscape Lighting

Improve nighttime aesthetics and safety

56

Facade Lighting

Enhance and illuminate landscape features

COMPANY PROFILE

We believe energy is precious and should be harnessed with care. We have embarked on a journey to bring the world a step closer to being carbon neutral and we want you to be part of it. Putting the needs of our customers first, we provide solutions to reduce existing lighting and electricity usage, saving you more in the long run.

We focus on improving the luminaire performances and the driver effectiveness with greater optimization of energy efficiency through providing R&D services in the form of tailor made custom designs or retrofits.

COMPANY VALUES

- Focused on identifying and servicing customer's needs
- Continuously creating additional value, which will increase benefits to customers
- Has strategic intentions & goals, which are clear and worked towards by everyone
- Conducts business in a professional and ethical manner
- Environmentally sensitive
- Communicates effectively with all stakeholders
- Values supplier relationships

OUR MISSION

To support organizations in the concept of Go Green & ECO-Friendly Environment and compliance to RoHS (Restriction of Hazardous Substances)

OUR VISION

To play an integral role in connecting the World to Safe Energy & Reduce CO₂

QUALITY POLICY

Exceptional customer care and quality products are our Top Priorities. **LigLED** commits to continually improve the value of its products and services to ensure total customer satisfaction by:

- Consistently meeting or exceeding customers' expectations for product quality and performance
- Timely delivery of products and services to meet customers' requirements
- Continually improve its processes and systems

LIGLED'S SIGNATURE

- **Human Safety** - All products comply with IEC standard for fire and electrical stock prevention and product robustness.
- **Energy Efficiency** - Provides higher luminous efficacy (higher lumens / wattage with lower power lost), reducing the amount of energy required. Saves > 80% of the energy with optimum usage.
- **Environmental Health Life** - Applies Good Quality Product Materials compliance to RoHS. Materials selected are hazardless and conducive to healthy environment and good quality of life, bringing less irritations to the eyes, brain and skin.

OUR ROADMAP

- FOUNDATION
- INDUSTRIAL SERVICES SUPPORT

- SUPPLY USED/ REFURBISHED PCBA MACHINERY

- PCB ASSEMBLY MANUFACTURING FOR MEDICAL & ELECTRICAL PRODUCTS

1997



- iECO LIGHTING SOLUTIONS SDN BHD ESTABLISHED
- DEVELOPED ECOPB20 DRIVER

2001



2005



2018

2011



- OWN LUMINAIRE MANUFACTURING BRAND - "LIGLED"
- SALES & MARKETING FOR INDUSTRIES AND OTHERS
- EFFICIENT SOLUTION SERVICES SUPPORT

2009



- RESEARCH & DEVELOPMENT ON T8 LED TUBE & DRIVER (LIGPB)

2019

- LIGLED DRAGON MYANMAR ESTABLISHED
- PT. LIGLED CAHAYA INDONESIA ESTABLISHED
- DEVELOPED NEW STREET LIGHT W/ NEMA SOCKET & HIGH MAST LIGHT

2020

- DEVELOPED SMART LIGHTS
- DEVELOPED FACADE LIGHTS

2021

- DEVELOPED UVC LED LINEAR BATTEN
- DEVELOPED UVC LED STRIP BAR

PRODUCTION FACILITY

Our proprietary hardware takes it another step further by ensuring that the products you use are cost-efficient for both the environment and your wallet. Our luminaires are designed with energy efficiency and sustainability in mind.



INCOMING GOODS



SMT LINE



PRODUCTION LINE



FINISHED GOODS

Our assembly line is ISO 9001: 2015 certified and operated by trained professionals to ensure we deliver products of optimum quality to our customers. At **LigLED**, we pride ourselves to give only the best to our customers.

RESEARCH & DEVELOPMENT

Here, we believe that innovation never stops. Our strong R&D team is constantly striving to ensure that we bring greater value to you and the world. All our products are RoHS compliant, that means you can use our products without worrying.



RESEARCH & DEVELOPMENT

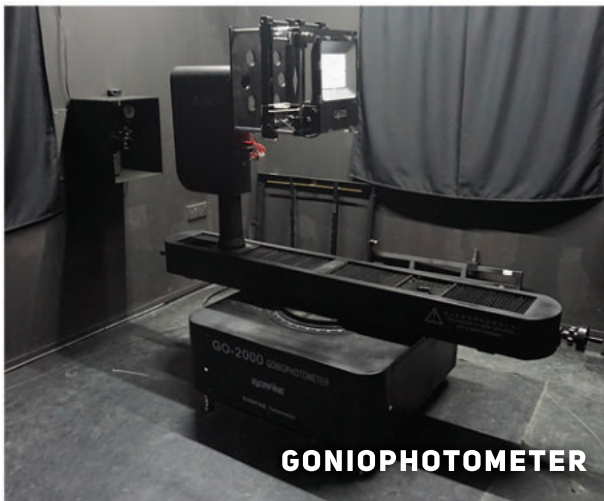

GONIOPHOTOMETER



QC & TESTING



INTERGRATING SPHERE SYSTEM

We continuously innovate and improve on our luminaires, and develop new ones to provide a comprehensive and high quality range of **LigLED** lightings to fulfill the wants and needs of our customers.

CERTIFICATIONS & AWARDS

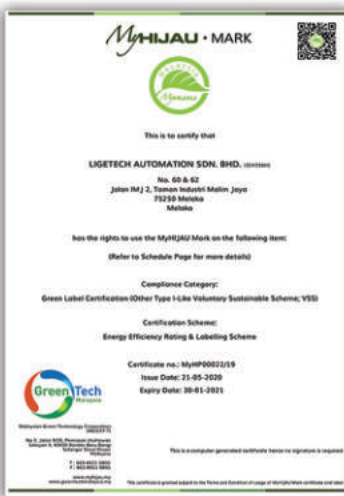

PROJECT REFERENCES

GOVERNMENT AGENCIES / GOVERNMENT LINKED COMPANIES



COMMERCIAL



INDUSTRIAL



COMMERCIAL LIGHTING

T8 LED TUBE (ECO PREMIUM PLUS SERIES)

COMMERCIAL LIGHTING

KEY FEATURES

- Product Lifespan 60,000 Hours
- Built-In Aluminium Heat Sink For Good Heat Dissipation
- Super High Brightness
- Energy Saving Up To 80%
- High Power Efficiency > 90%
- Operating Temp: -20°C to 50°C



DESCRIPTION	SPECIFICATION			
Part Number (Single End. Supply)	LTV2S-P09ES3PM□	LTV8-P09ES3PM□	LTV8-P12ES3PM□	LTV8-P16ES3PM□
Part Number (Double End. Supply)	LTV2S-P09E3PM□	LTV8-P09E3PM□	LTV8-P12E3PM□	LTV8-P16E3PM□
Wattage (W)	9W	9.5W	12W	16W
Colour Rendering Index (CRI)	85			
Beam Angle	160°			
Lumen (lm)	1,400	1,600	2,100	2,650
Luminous Efficacy (lm/w)	155	168	173	166
Material	Polycarbonate (PC) Milky Diffuser (Option: Clear Diffuser)			
Dimension (mm)	Ø: 26 x L: 600	Ø: 26 x L: 1200		
Weight (gm)	120	210		
Lamp Base	G13			
Ingress Protection (IP)	IP20			
Lifespan (hrs)	60,000			
Driver	Internal - Non Dimming (Comply with JKR Spec)			
Input Voltage	220-240Vac (50/60 Hz)			
Power Factor (PF)	> 0.90			
Total Harmonic Distortion (THD)	< 12%			

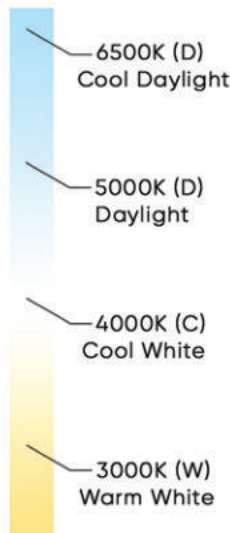
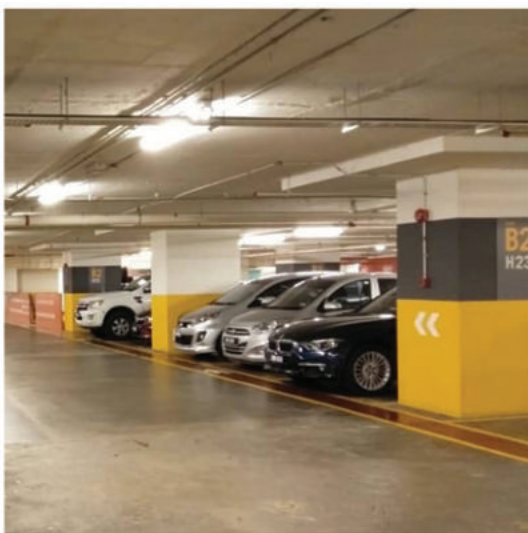

PHOTOMETRIC DATA Luminous Intensity Distribution Diagram

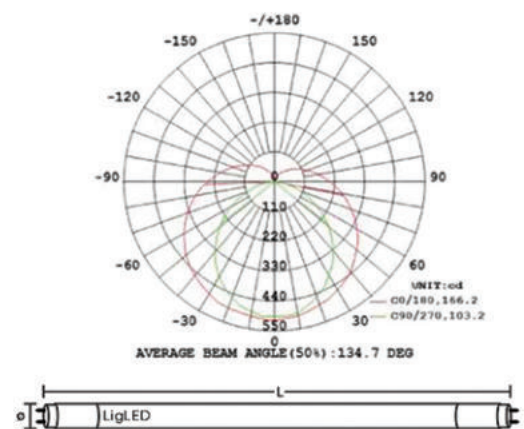

✉ sales@ligled.com.my
☎ +606-3365 696
☎ +6016-771 5697

LIGLED.COM.MY

/LIGLED



T8 LED TUBE (ECO MASTER SERIES)

KEY FEATURES

- Product Lifespan 50,000 hours
- Long Life Cycles
- Built-In Aluminium Heat Sink For Good Heat Dissipation
- Energy Saving Up To 70%
- High Power Efficiency > 90%
- Operating Temp: -20°C to 50°C



Retail Office
Industrial Hospitality

COMMERCIAL LIGHTING

DESCRIPTION	SPECIFICATION			
Part Number (Single End. Supply)	LTV2S-P09ES3M□	LTV8-P12ES3M□	LTV8-P16ES3M□	LTV8-P20ES3M□
Part Number (Double End. Supply)	LTV2S-P09E3M□	LTV8-P12E3M□	LTV8-P16E3M□	LTV8-P20E3M□
Wattage (W)	9W	12W	16W	20W
Colour Rendering Index (CRI)	85			
Beam Angle	160°			
Lumen (lm)	1,300	1,800	2,300	2,900
Luminous Efficacy (lm/w)	145	150	144	145
Material	Polycarbonate (PC) Milky Diffuser (Option: Clear Diffuser)			
Dimension (mm)	Ø: 26 x L: 600	Ø: 26 x L: 1200	Ø: 26 x L: 1500	
Weight (gm)	117	206	246	
Lamp Base	G13			
Ingress Protection (IP)	IP20			
Lifespan (hrs)	50,000			
Driver	Internal - Non Dimming (Comply with JKR Spec)			
Input Voltage	220-240Vac (50/60 Hz)			
Power Factor (PF)	> 0.90			
Total Harmonic Distortion (THD)	< 12%			

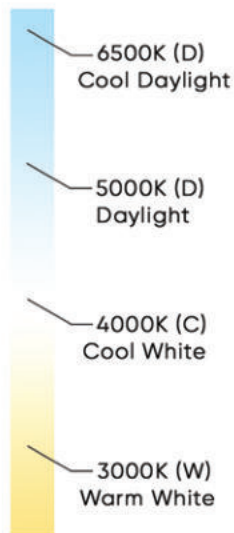

PHOTOMETRIC DATA Luminous Intensity Distribution Diagram

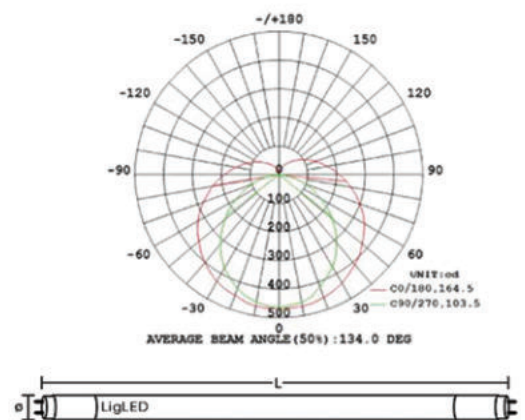

✉ sales@ligled.com.my

☎ +606-3365 696

☎ +6016-771 5697

LIGLED.COM.MY

/LIGLED



CB 10

T8 LED TUBE (ECO ELITE SERIES)

KEY FEATURES

- Product Lifespan 35,000 Hours
- Less Heat Produced
- Built-In Aluminium Heat Sink For Good Heat Dissipation
- Energy Saving Up To 60%
- High Power Efficiency > 90%
- Operating Temp: -20°C to 50°C



Retail



Office



Industrial



Hospitality

DESCRIPTION		SPECIFICATION		
Part Number (Single End. Supply)	LTV2S-P09ES3EM□	LTV8-P16ES3EM□	LTV8-P18ES3EM□	
Part Number (Double End. Supply)	LTV2S-P09E3EM□	LTV8-P16E3EM□	LTV8-P18E3EM□	
Wattage (W)	9W	16W	18W	
Colour Rendering Index (CRI)		85		
Beam Angle		160°		
Lumen (lm)	1,000	1,800	2,000	
Luminous Efficacy (lm/w)	111	113	111	
Material	Polycarbonate (PC) Milky Diffuser (Option: Clear Diffuser)			
Dimension (mm)	Ø: 26 x L: 600	Ø: 26 x L: 1200		
Weight (gm)	117	206		
Lamp Base		G13		
Ingress Protection (IP)		IP20		
Lifespan (hrs)		35,000		
Driver		Internal - Non Dimming		
Input Voltage		220-240Vac (50/60 Hz)		
Power Factor (PF)		> 0.90		
Total Harmonic Distortion (THD)		< 12%		

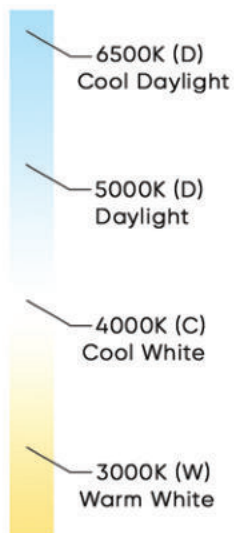

PHOTOMETRIC DATA Luminous Intensity Distribution Diagram

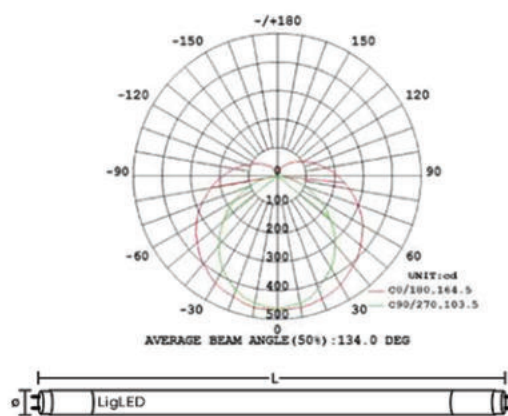

✉ sales@ligled.com.my

☎ +606-3365 696

☎ +6016-771 5697

T5 LED TUBE (ECO MASTER/MASTER PLUS SERIES)

KEY FEATURES

- Product Lifespan > 50,000 Hours
- Longer Life Cycles
- Great Heat Dissipation
- Energy Saving Up To 60%
- High Power Efficiency > 90%
- Operating Temp: -20°C to 65°C
- Design For Easy Replacement



COMMERCIAL LIGHTING

DESCRIPTION	ECO MASTER			ECO MASTER PLUS	
	LTSSE-A09E3M□	LTSSE-A16E3M□	LTSSE-A09E3PM□	LTSSE-A16E3PM□	LTSSE-A20E3PM□
Part Number	LTSSE-A09E3M□	LTSSE-A16E3M□	LTSSE-A09E3PM□	LTSSE-A16E3PM□	LTSSE-A20E3PM□
Wattage (W)	9W	16W	9W	16W	20W
Colour Rendering Index (CRI)			85		
Beam Angle			150°		
Lumen (lm)	1,200	2,300	1,350	2,500	3,000
Luminous Efficacy (lm/w)	133	144	150	156	150
Material	Half Aluminium + Half Polycarbonate (PC) Milky Diffuser (Option: Clear Diffuser)				
Dimension (mm)	Ø: 18 x L: 580	Ø: 18 x L: 1160	Ø: 18 x L: 580	Ø: 18 x L: 1160	Ø: 18 x L: 1160
Weight (gm)	80	165	80	165	165
Lamp Base	G5				
Ingress Protection (IP)	IP20				
Lifespan (hrs)	50,000				
Driver	External - Non Dimming				
Input Voltage	220-240Vac (50/60 Hz)				
Power Factor (PF)	> 0.90				
Total Harmonic Distortion (THD)	< 12%				

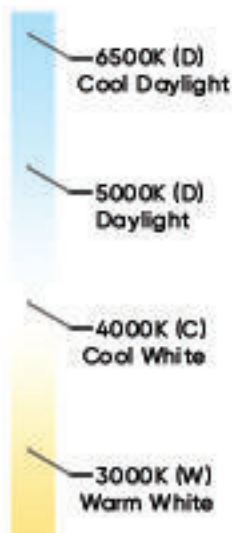

PHOTOMETRIC DATA

Luminous Intensity Distribution Diagram

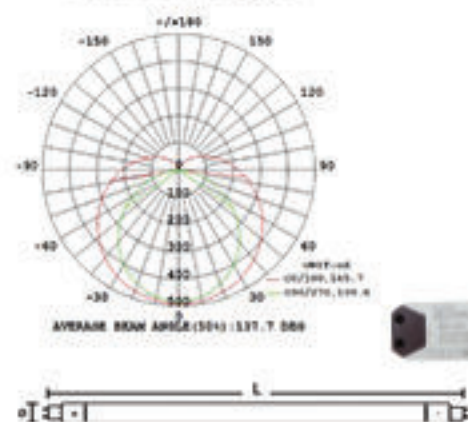

sales@ligled.com.my
+606-3365 696
+6016-771 5697

LIGLED.COM.MY

/LIGLED



CB 12

T5 LED TUBE (ECO PREMIERE/PREMIERE PLUS SERIES)

KEY FEATURES

- Product Lifespan > 50,000 Hours
- Longer Life Cycles
- Great Heat Dissipation
- Energy Saving Up To 60%
- High Power Efficiency > 90%
- Operating Temp: -20°C to 65°C
- Design For Easy Replacement



DESCRIPTION	ECO PREMIERE		ECO PREMIERE PLUS	
	LTS-A09E3M□	LTS-A16E3M□	LTS-A09E3PM□	LTS-A16E3PM□
Part Number	LTS-A09E3M□	LTS-A16E3M□	LTS-A09E3PM□	LTS-A16E3PM□
Wattage (W)	9W	16W	9W	16W
Colour Rendering Index (CRI)	85			
Beam Angle	150°			
Lumen (lm)	1,200	2,300	1,350	2,500
Luminous Efficacy (lm/w)	133	144	150	156
Material	Half Aluminium + Half Polycarbonate (PC) Milky Diffuser (Option: Clear Diffuser)			
Dimension (mm)	Ø: 18 x L: 580	Ø: 18 x L: 1160	Ø: 18 x L: 580	Ø: 18 x L: 1160
Weight (gm)	80	165	80	165
Lamp Base	G5			
Ingress Protection (IP)	IP20			
Lifespan (hrs)	50,000			
Driver	External - Non Dimming / Dimming 1-10V, Phase Cut, DALI			
Driver Part Number	LLD19W350□		LLD38W700□	
Input Voltage	220-240Vac (50/60 Hz)			
Power Factor (PF)	> 0.90			
Total Harmonic Distortion (THD)	< 20%			

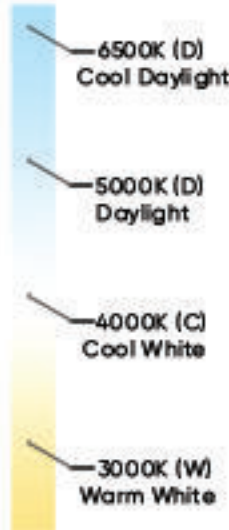

PHOTOMETRIC DATA

Luminous Intensity Distribution Diagram

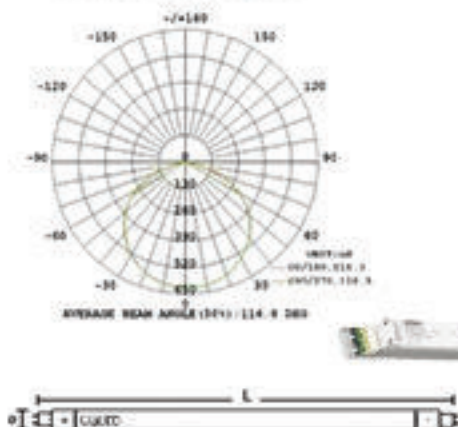

PLL LED TUBE (ECO MASTER/MASTER PLUS/PREMIERE SERIES)

KEY FEATURES

- Product Lifespan 50,000 Hours
- Longer Life Cycles
- Great Heat Dissipation
- Energy Saving Up To 80%
- High Power Efficiency > 90%
- Operating Temp: -20°C to 65°C

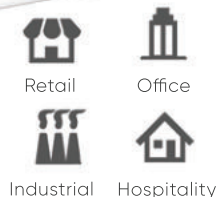

COMMERCIAL LIGHTING

DESCRIPTION	SPECIFICATION		
	ECO MASTER	ECO MASTER PLUS	ECO PREMIERE
Part Number	LPLLSE-A16E3M□	LPLLSE-A12E3PM□	LPLL-A16E3M□
Wattage (W)	16W	12W	16W
Colour Rendering Index (CRI)		85	
Beam Angle		120°	
Lumen (lm)	2,300	1,900	2,300
Luminous Efficacy (lm/w)	144	158	144
Material	Half Aluminium + Half Polycarbonate (PC) Milky Diffuser (Option: Clear Diffuser)		
Dimension (mm)	L: 415 x W: 43 x H: 23		
Weight (gm)	195		
Lamp Base	2G11 4Pin		
Ingress Protection (IP)	IP20		
Lifespan (hrs)	50,000		
Driver	External - Non Dimming / Dimming 1-10V, Phase Cut, DALI		
Driver Part Number	ECOPB20		LLD38W700□
Input Voltage	220-240Vac (50/60 Hz)		
Power Factor (PF)	> 0.90		
Total Harmonic Distortion (THD)	< 12%		< 20%

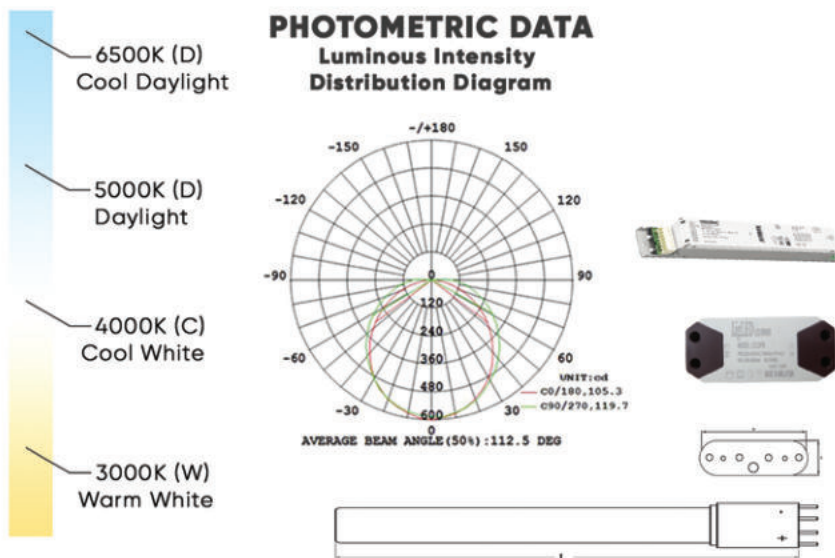
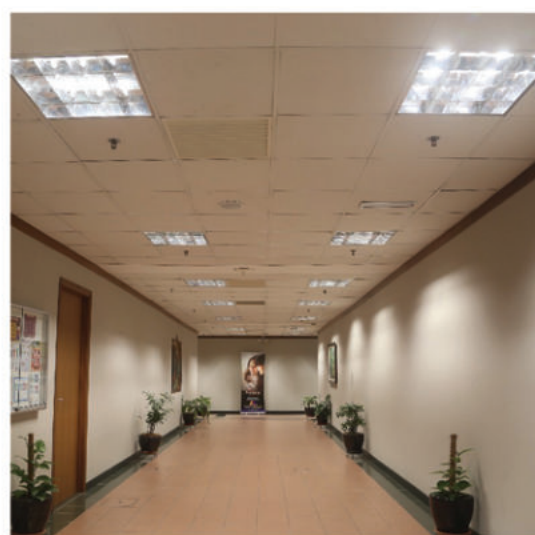

✉ sales@ligled.com.my
☎ +606-3365 696
☎ +6016-771 5697

LIGLED.COM.MY

/LIGLED

Suruhanjaya Tenaga
Energy Commission

MS

MADE IN MALAYSIA

RoHS

COMPLIANT

CB

14

LED MODULAR PANEL LIGHT (MASTER/PREMIERE SERIES)

COMMERCIAL LIGHTING

KEY FEATURES

- Stylish Design
- Higher Lumen Output
- Easy & Low Maintenance
- Long Product Lifespan
- Back LED With Great Luminaire Performance



Retail



Office



Industrial



Hospitality

DESCRIPTION	SPECIFICATION		
Part Number	LMP606□-A40E3M□	LMP312□-A40E3PM□	LMP612□-A50E3PM□
Wattage (W)	40W	40W	50W
Colour Rendering Index (CRI)	85		
Beam Angle	120°		
Lumen (lm)	4,600	4,500	5,500
Luminous Efficacy (lm/w)	115	113	110
Material	Modular Aluminium Panel + Polycarbonate (PC) Milky Diffuser		
Dimension (mm)	L: 600 x W: 600 x H: 65	L: 1200 x W: 300 x H: 65	L: 1200 x W: 600 x H: 65
Weight (gm)	4000	6000	8000
Ingress Protection (IP)	IP20 / IP44		
Lifespan (hrs)	50,000		
Driver	External - Non Dimming / Dimming 1-10V, Phase Cut, DALI		
Input Voltage	220-240Vac (50/60 Hz)		
Power Factor (PF)	> 0.90		
Total Harmonic Distortion (THD)	< 20%		

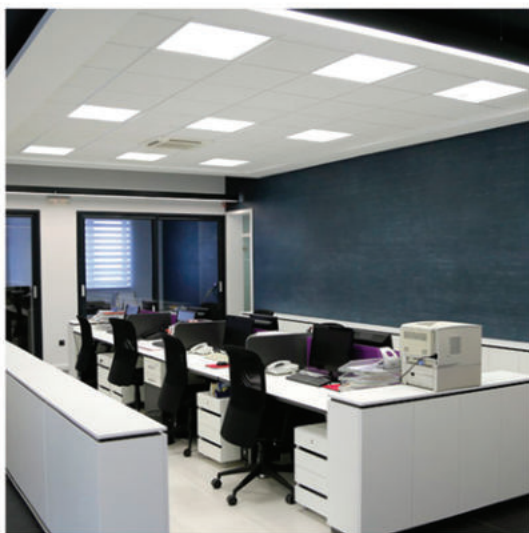

PHOTOMETRIC DATA

Luminous Intensity Distribution Diagram

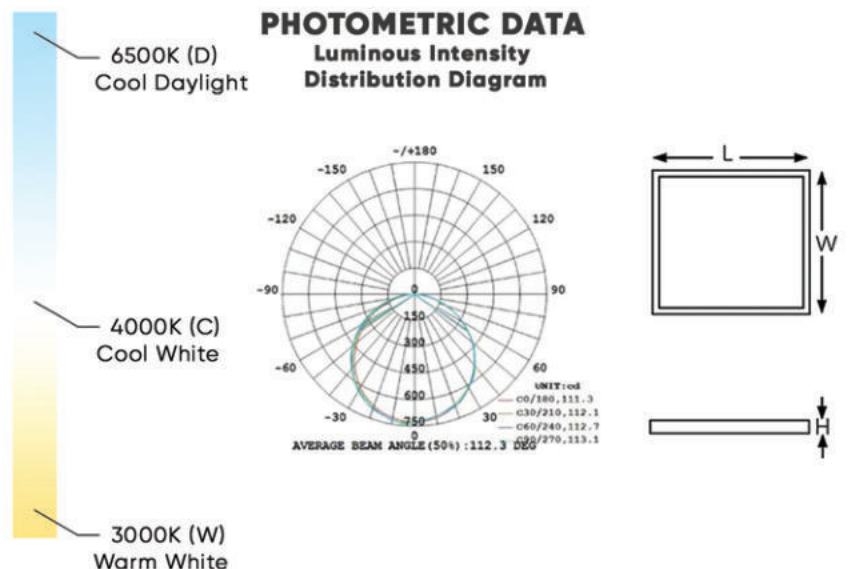

✉ sales@ligled.com.my

☎ +606-3365 696

☎ +6016-771 5697

LIGLED.COM.MY

/LIGLED



LED LINEAR STRIP BAR (24V SERIES)

KEY FEATURES

- Perfect Use For Architectural Lighting
- For Interior & Exterior Lighting Decoration
- Slim Design-Use Under Cabinet, Over Cabinet, Cove Lighting
- Easy & Low Maintenance
- Homogenous Linear Light

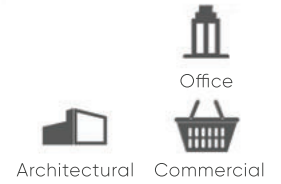

COMMERCIAL LIGHTING

DESCRIPTION	SPECIFICATION				
Part Number	LLSB□□□24E-A□□E3P□			LLSB□□□24E-A□□E3PP□	
Wattage (W)	10W/M	14W/M	18W/M	15W/M	20W/M
Colour Rendering Index (CRI)	85 / 95				
Beam Angle	150°				
Lumen (lm)	1,100	1,500	1,900	1,900	2,500
Luminous Efficacy (lm/w)	110	107	106	126	125
Material	Aluminium Bar Profile + Polycarbonate (PC) Milky Diffuser				
Dimension (mm)	L: 1000 x W: 17.5 x H: 12		L: 1000 x W: 17.5 x H: 7	L: 1000 x W: 17 x H: 8	
Weight (gm)	Approx : 200				
Ingress Protection (IP)	IP20 / IP65				
Lifespan (hrs)	50,000				
Driver	External - 24V Non Dimming / Dimming 1-10V, DALI				
Driver Part Number	LMW24V-□□W		LOMW24V-□□W		
Input Voltage	24 Vdc				
Driver Ingress Protection (IP)	IP20			IP67	

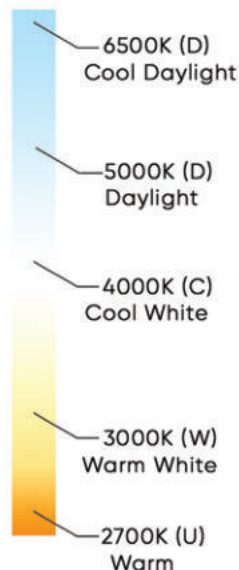
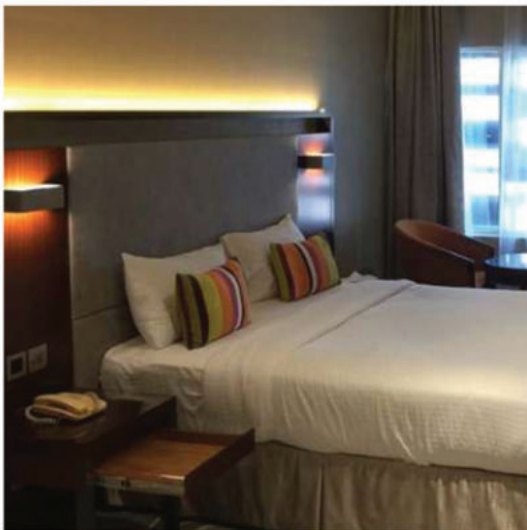

PHOTOMETRIC DATA Luminous Intensity Distribution Diagram

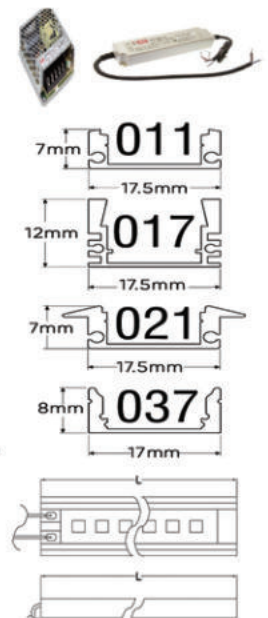
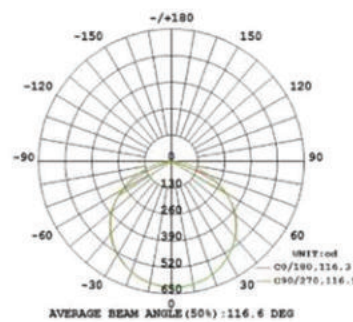

sales@ligled.com.my
+606-3365 696
+6016-771 5697

LIGLED.COM.MY

/LIGLED



LED STRIP BAR (12V/24V SERIES)

KEY FEATURES

- Suitable Replacement For Advertisements, Light Box, Freeze Cover, Ceiling & Others
- Low Power & Save Up To 60% Energy
- Long Life Cycles
- Easy & Low Maintenance
- No Mercury



Retail



Office



Industrial



Hospitality

DESCRIPTION		SPECIFICATION			
Part Number	LSB1M12E-A□□E3C□	LSB1M24E-A□□E3C□			
Wattage (W)	10W/M	14W/M	10W/M	14W/M	18W/M
Colour Rendering Index (CRI)	85				
Beam Angle	120°				
Lumen (lm)	900	1,200	1,300	1,800	2,300
Luminous Efficacy (lm/w)	90	86	130	129	128
Material	Aluminium Bar Profile + Clear Silicon Coating				
Dimension (mm)	L: 1,000 x W: 13 x H: 5				
Weight (gm)	100				
Ingress Protection (IP)	IP44 / IP65				
Lifespan (hrs)	50,000				
Driver	External - 12V/24V Non Dimming / Dimming 1-10V, DALI				
Driver Part Number	LMW12V-□□□W		LOMW24V-□□□W		
Input Voltage	12 Vdc		24 Vdc		
Driver Ingress Protection (IP)	IP20		IP67		

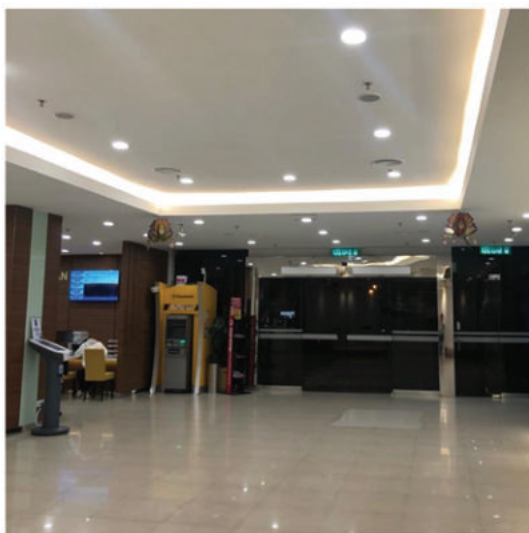

- 6500K (D) Cool Daylight
- 5000K (D) Daylight
- 4000K (C) Cool White
- 3000K (W) Warm White
- 2700K (U) Warm

PHOTOMETRIC DATA

Luminous Intensity Distribution Diagram

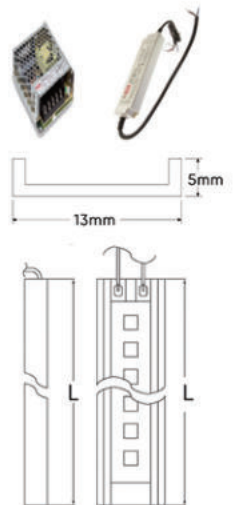
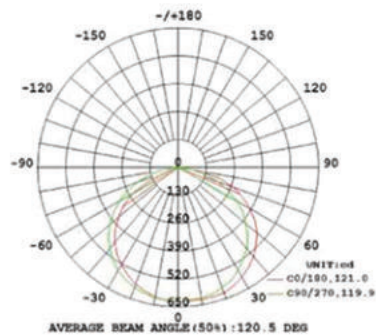

✉ sales@ligled.com.my

☎ +606-3365 696

☎ +6016-771 5697



LIGLED.COM.MY



/LIGLED



LED LINEAR POWERCOVE BAR (24V SERIES)

KEY FEATURES

- Precise Architectural Form
- Installed In Traditional Ceiling Cove & Indirect Area
- Highly Innovative Solution
- Provide Uniform Diffused Light
- Easy & Low Maintenance
- 45° Angle Light Output

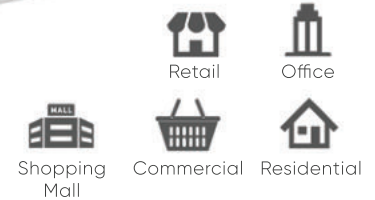

COMMERCIAL LIGHTING

DESCRIPTION		SPECIFICATION			
Part Number		LLPB□□□ 24E-A□□E3P□		LLPB□□□ 24E-A□□E3PP□	
Wattage (W)		10W/M	14W/M	18W/M	20W/M
Colour Rendering Index (CRI)		85 / 95			
Beam Angle		120°			
Lumen (lm)		1,300	1,800	2,300	2,900
Luminous Efficacy (lm/w)		130	129	128	143
Material		Aluminium Bar Profile + Milky Diffuser (Option: Clear Diffuser)			
Dimension (mm)		L: 1000 x W: 16 x H: 16		L: 1000 x W: 30 x H: 30	
Weight (gm)		Approx : 200			
Ingress Protection (IP)		IP20 / IP65			
Lifespan (hrs)		50,000			
Driver		External - 24V Non Dimming / Dimming 1-10V, DALI			
Driver Part Number		LMW24V-□□W		LOMW24V-□□W	
Input Voltage		24 Vdc			
Driver Ingress Protection (IP)		IP20		IP67	

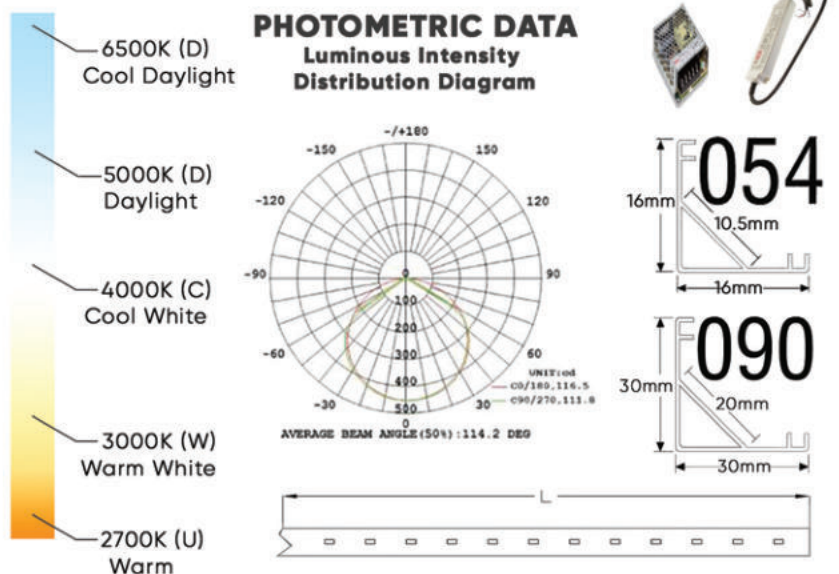

sales@ligled.com.my
+606-3365 696
+6016-771 5697

LIGLED.COM.MY

/LIGLED

Suruhanjaya Tenaga Energy Commission

MS

BUKITA MALAYA MADE IN MALAYSIA

RoHS COMPLIANT

RoHS COMPLIANT

CB

18

LED LINEAR BATTEN (ECO MASTER SERIES)

COMMERCIAL LIGHTING

KEY FEATURES

- Perfect Use For Architectural Lighting
- Bright Light With Uniform Output
- Elegant Looking Design
- Used For Interior Lighting Decoration



Retail



Office



Industrial



Hospitality

DESCRIPTION	SPECIFICATION				
Part Number	LLB00306IS-A20E3P□	LLB00311IS-A40E3P□	LLB00311IS-A40E3P□	LLB00315IS-A50E3P□	LLB00315IS-A50E3P□
		LLB00406IS-A20E3P□	LLB00411IS-A40E3P□		
Wattage (W)	20W	20W	40W	40W	50W
Colour Rendering Index (CRI)			85		
Beam Angle			120°		
Lumen (lm)	2,000	2,000	4,000	4,000	5,000
Luminous Efficacy (lm/w)	100	100	100	100	100
Material		Aluminium + Polycarbonate (PC) Milky Diffuser			
Dimension (mm)	L: 600 x W: 50 x H: 55	L: 600 x W: 50 x H: 70	L: 1120 x W: 50 x H: 55	L: 1120 x W: 50 x H: 70	L: 1500 x W: 50 x H: 55
Weight (gm)		Approx: 850		Approx: 1250	Approx: 1500
Ingress Protection (IP)			IP20		
Lifespan (hrs)			50,000		
Driver	External - Non Dimming / Dimming 1-10V, Phase Cut, DALI				
Input Voltage	220-240Vac (50/60 Hz)				
Power Factor (PF)	> 0.90				
Total Harmonic Distortion (THD)	< 20%				

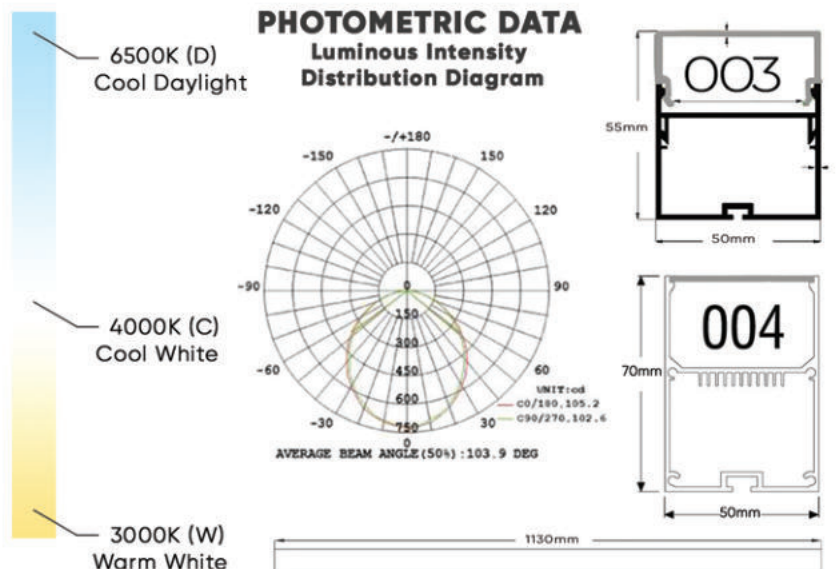

✉ sales@ligled.com.my

☎ +606-3365 696

☎ +6016-771 5697



LIGLED.COM.MY



/LIGLED



INDOOR LIGHTING

LED DOWN LIGHT ROUND (ECO PREMIERE SERIES)

KEY FEATURES

- Superior Quality To Reduce Eye Glare
- Provide Balanced & Comfortable Lighting Output
- Excellent Heat Dissipation Design
- Design To Operate > 8 Hours
- Lifespan 60,000 Hours



INDOOR LIGHTING

DESCRIPTION	SPECIFICATION					
Part Number	LD4RC□-A08O5P□	LD6RC□-A15O5P□		LD8RC□-A15O5P□		
		LD4RC□-A15O5P□	LD6RC□-A19O5P□		LD8RC□-A19O5P□	
Wattage (W)	8W	15W	15W	19W	15W	19W
Colour Rendering Index (CRI)			85			
Beam Angle			120°			
Lumen (lm)	800	1,600	1,650	2,100	1,650	2,100
Luminous Efficacy (lm/w)	100	106	110	110	110	110
Material	Fully Aluminium + Polycarbonate (PC) Milky Diffuser					
Dimension (mm)	Ø: 145 x H: 50		Ø: 175 x H: 55		Ø: 220 x H: 70	
Cut Hole Size (mm)	120		145		170	
Weight (gm)	235		275		417	
Ingress Protection (IP)			IP20 /IP44			
Lifespan (hrs)			60,000			
Driver	External - Non Dimming / Dimming 1-10V, Phase Cut, DALI					
Input Voltage	220-240Vac (50/60 Hz)					
Power Factor (PF)			> 0.90			
Total Harmonic Distortion (THD)			< 20%			

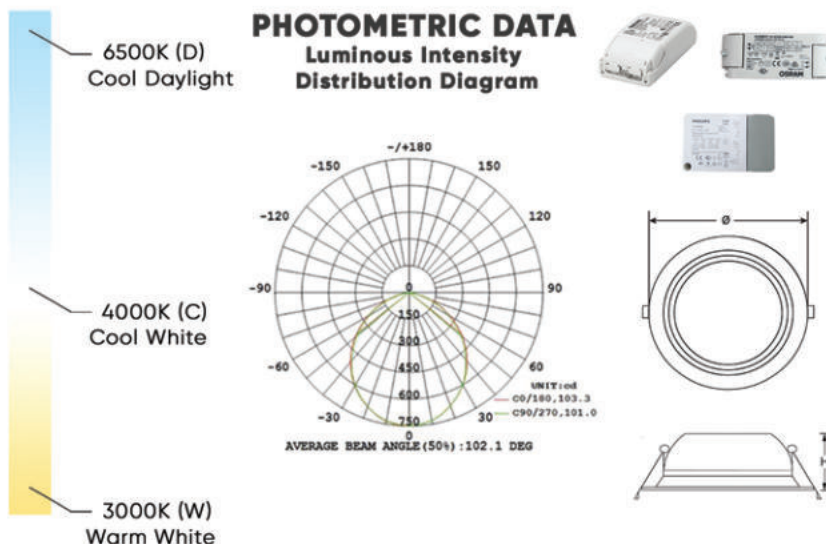

✉ sales@ligled.com.my

☎ +606-3365 696

☎ +6016-771 5697

LIGLED.COM.MY

/LIGLED



LED DOWN LIGHT ROUND (ECO PREMIERE PLUS SERIES)

KEY FEATURES

- Superior Quality To Reduce Eye Glare
- Provide Balanced & Comfortable Lighting Output
- Excellent Heat Dissipation Design
- Design To Operate > 8 Hours
- Lifespan 60,000 Hours

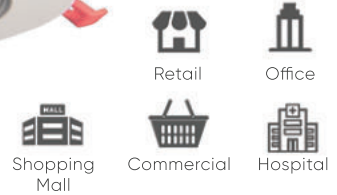

INDOOR LIGHTING

DESCRIPTION	SPECIFICATION				
Part Number	LD10RC□-A29E3PP□	LD10RC□-A33E3PP□	LD10RC□-A39E3PP□	LD10RC□-A44E3PP□	LD10RC□-A50E3PP□
Wattage (W)	29W	33W	39W	44W	50W
Colour Rendering Index (CRI)			85		
Beam Angle	120°				
Lumen (lm)	3,900	4,450	5,000	5,500	6,000
Luminous Efficacy (lm/w)	134	135	128	125	120
Material	Fully Aluminium + Polycarbonate (PC) Milky Diffuser				
Dimension (mm)	Ø: 240 x H: 70				
Cut Hole Size (mm)	170				
Weight (gm)	550				
Ingress Protection (IP)	IP20 / IP44				
Lifespan (hrs)	60,000				
Driver	External - Non Dimming / Dimming 1-10V, Phase Cut, DALI				
Input Voltage	220-240Vac (50/60 Hz)				
Power Factor (PF)	> 0.90				
Total Harmonic Distortion (THD)	< 20%				

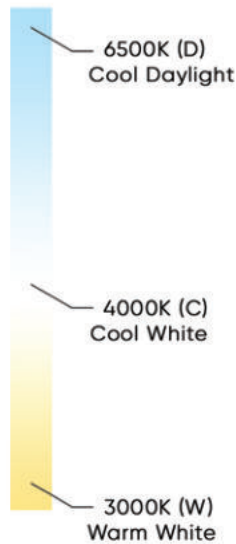

PHOTOMETRIC DATA Luminous Intensity Distribution Diagram

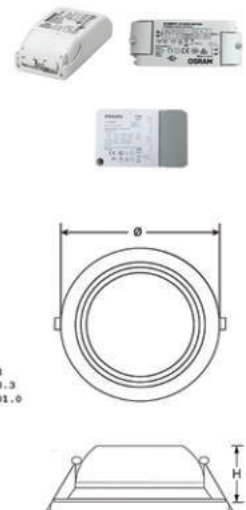
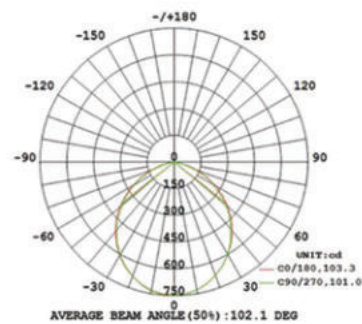

✉ sales@ligled.com.my
☎ +606-3365 696
📞 +6016-771 5697

LIGLED.COM.MY

/LIGLED

Suruhanjaya Tenaga
Energy Commission

MS

MADE IN MALAYSIA

RoHS

CB

22

LED DOWN LIGHT ROUND (ECO MASTER PLUS SERIES)

KEY FEATURES

- Superior Quality To Reduce Eye Glare
- Provide Balanced & Comfortable Lighting Output
- Excellent Heat Dissipation Design
- Enjoy Energy Savings Over 60%

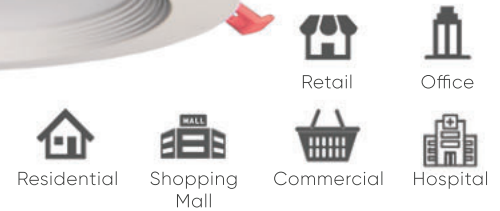

INDOOR LIGHTING

DESCRIPTION	SPECIFICATION					
Part Number	LD6RCS-A08E3PP□	LD8RCS-A12E3PP□		LD10RCS-A15E3PP□		
		LD6RCS-A12E3PP□	LD8RCS-A15E3PP□	LD10RCS-A21E3PP□		
Wattage (W)	8W	12W	12W	15W	15W	21W
Colour Rendering Index (CRI)			85			
Beam Angle			120°			
Lumen (lm)	1,200	1,800	1,800	2,200	2,200	3,100
Luminous Efficacy (lm/w)	150	150	150	148	148	148
Material	Fully Aluminium + Polycarbonate (PC) Milky Diffuser					
Dimension (mm)	Ø: 175 x H: 55		Ø: 220 x H: 70		Ø: 240 x H: 70	
Cut Hole Size (mm)	145		170		170	
Weight (gm)	275		417		550	
Ingress Protection (IP)			IP20 / IP44			
Lifespan (hrs)			60,000			
Driver			External - Non Dimming			
Input Voltage			220-240Vac (50/60 Hz)			
Power Factor (PF)			> 0.90			
Total Harmonic Distortion (THD)			< 12%			

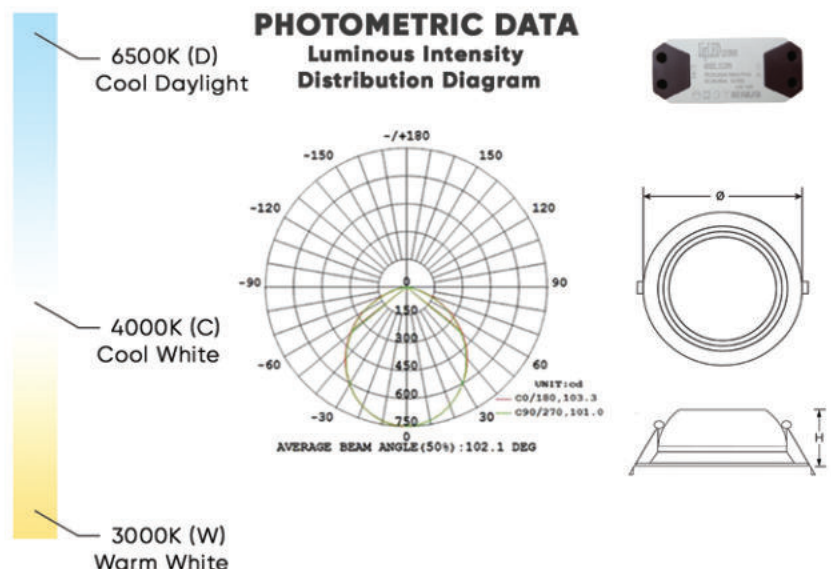

✉ sales@ligled.com.my
☎ +606-3365 696
☎ +6016-771 5697

LIGLED.COM.MY /LIGLED



LED DOWN LIGHT ROUND (ECO MASTER SERIES)

KEY FEATURES

- Superior Quality To Reduce Eye Glare
- Provide Balanced & Comfortable Lighting Output
- Excellent Heat Dissipation Design
- Enjoy Energy Savings Over 60%

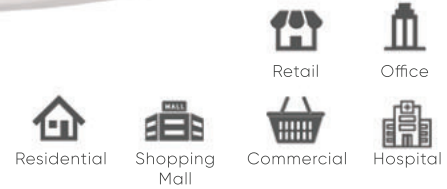

INDOOR LIGHTING

DESCRIPTION	SPECIFICATION						
Part Number	LD4RCS-A10E3P□	LD6RCS-A16E3P□	LD8RCS-A21E3P□	LD10RCS-A21E3P□	LD6RCS-A12E3P□	LD8RCS-A16E3P□	LD10RCS-A16E3P□
Wattage (W)	10W	12W	16W	16W	21W	16W	21W
Colour Rendering Index (CRI)	85						
Beam Angle	120°						
Lumen (lm)	1,000	1,200	2,000	2,000	2,600	2,000	2,600
Luminous Efficacy (lm/w)	100	100	125	125	124	125	124
Material	Fully Aluminium + Polycarbonate (PC) Milky Diffuser						
Dimension (mm)	Ø: 145 x H: 50	Ø: 175 x H: 55	Ø: 220 x H: 70	Ø: 240 x H: 70			
Cut Hole Size (mm)	120	145	170	170			
Weight (gm)	235	275	417	550			
Ingress Protection (IP)	IP20 / IP44						
Lifespan (hrs)	50,000						
Driver	External - Non Dimming						
Input Voltage	220-240Vac (50/60 Hz)						
Power Factor (PF)	> 0.90						
Total Harmonic Distortion (THD)	< 12%						

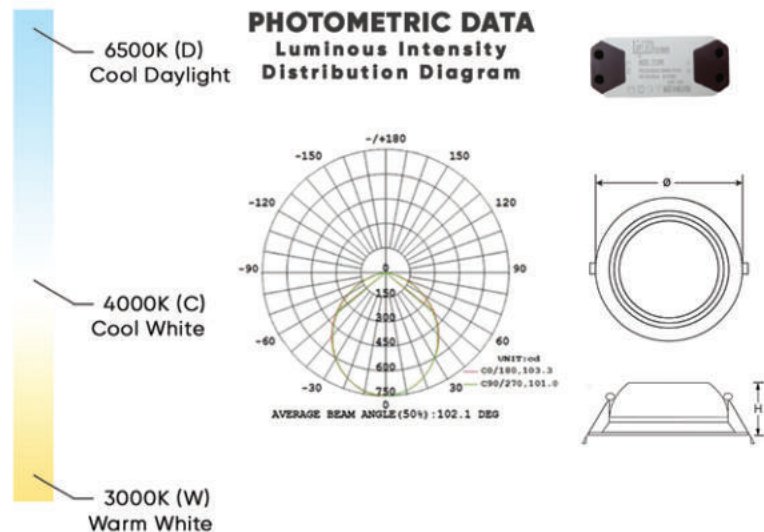
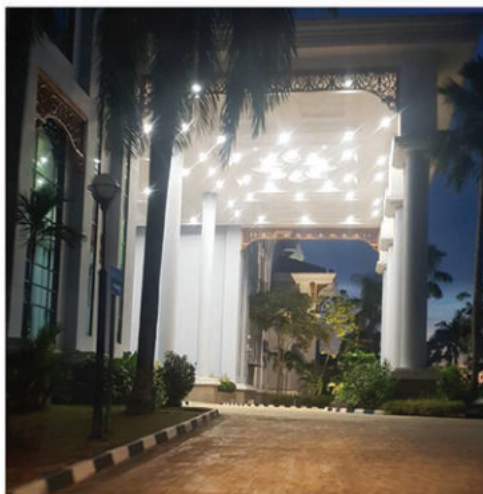

✉ sales@ligled.com.my

☎ +606-3365 696

☎ +6016-771 5697

LIGLED.COM.MY

/LIGLED



CB 24

LED DOWN LIGHT ROUND (ECO ELITE SERIES)

KEY FEATURES

- Product Lifespan 35,000 Hours
- Slim & Stylish Design
- Great Lumen Output Performance
- Produce Minimal Heat



INDOOR LIGHTING

DESCRIPTION	SPECIFICATION				
Part Number	LD3RES-A08E3P□	LD4RES-A10E3P□	LD6RES-A12E3P□	LD6RES-A18E3P□	LD8RES-A18E3P□
Wattage (W)	8W	10W	12W	18W	18W
Colour Rendering Index (CRI)	85				
Beam Angle	120°				
Lumen (lm)	700	900	1,000	1,600	1,600
Luminous Efficacy (lm/w)	88	90	83	88	88
Material	Aluminium + Polycarbonate (PC) Milky Diffuser				
Dimension (mm)	Ø: 120 x H: 30	Ø: 145 x H: 30	Ø: 180 x H: 30	Ø: 230 x H: 30	
Cut Hole Size (mm)	90	110	135	190	
Weight (gm)	165	192	274	426	
Ingress Protection (IP)	IP20 / IP44				
Lifespan (hrs)	35,000				
Driver	External - Non Dimming				
Input Voltage	220-240Vac (50/60 Hz)				
Power Factor (PF)	> 0.90				
Total Harmonic Distortion (THD)	< 12%				

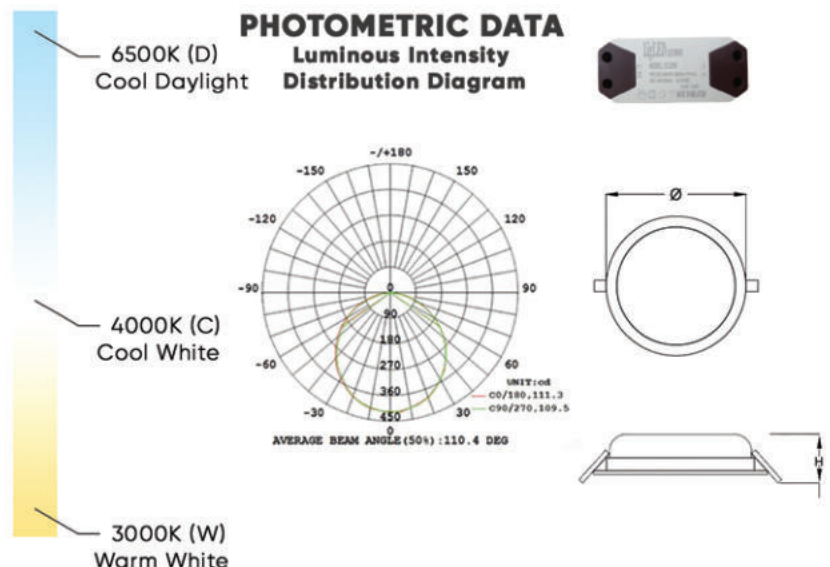
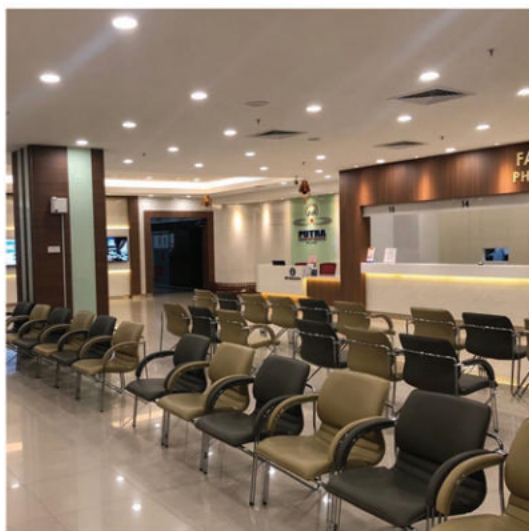

✉ sales@ligled.com.my
☎ +606-3365 696
☎ +6016-771 5697

LIGLED.COM.MY /LIGLED



LED DOWN LIGHT SQUARE (ECO MASTER SERIES)

KEY FEATURES

- Stylish Craft Light Design
- Excellent Heat Dissipation Design
- High Uniformity And Soft Lighting
- Design To Operate > 8 Hours
- Lifespan 50,000 Hours



DESCRIPTION	SPECIFICATION				
Part Number	LD4SCS-A10E3P□	LD6SCS-A10E3P□	LD6SCS-A15E3P□	LD8SCS-A15E3P□	LD8SCS-A21E3P□
Wattage (W)	10W	10W	15W	15W	21W
Colour Rendering Index (CRI)			85		
Beam Angle			120°		
Lumen (lm)	1,000	1,000	1,800	1,800	2,500
Luminous Efficacy (lm/w)	100	100	120	120	120
Material	Fully Aluminium + Polycarbonate (PC) Milky Diffuser				
Dimension (mm)	L: 140 x W: 140 x H: 60	L: 180 x W: 180 x H: 70	L: 220 x W: 220 x H: 70		
Cut Hole Size (mm)	120 x 120	150 x 150	200 x 200		
Weight (gm)	380	650	800		
Ingress Protection (IP)			IP20 / IP44		
Lifespan (hrs)			50,000		
Driver			External - Non Dimming		
Input Voltage			220-240Vac (50/60 Hz)		
Power Factor (PF)			> 0.90		
Total Harmonic Distortion (THD)			< 12%		

INDOOR LIGHTING

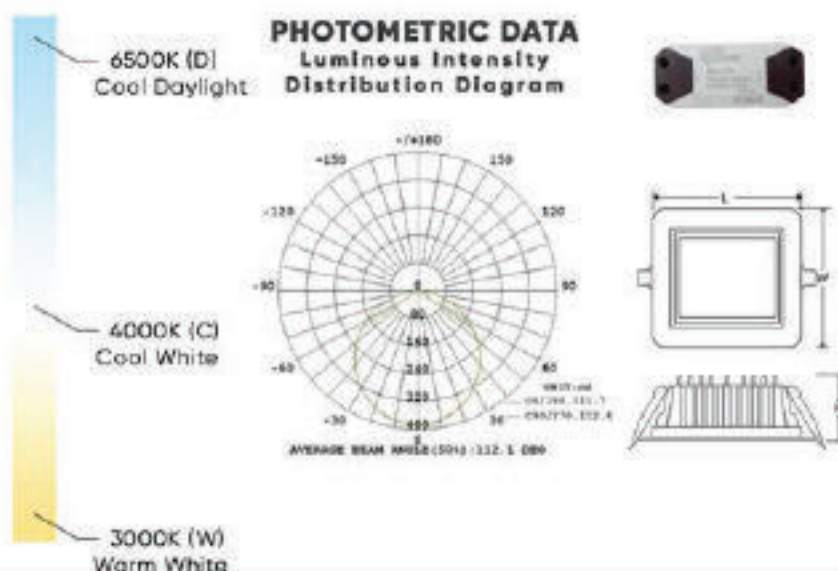

✉ sales@ligled.com.my

☎ +606-3365 696

☎ +6016-771 5697

🌐 LIGLED.COM.MY

📘 /LIGLED



LED DEEP SPOT DOWN LIGHT (PREMIUM PLUS SERIES)

KEY FEATURES

- Special Deep Anti-Glare Reflector Design
- Provide Balanced & Comfortable Lighting Output
- Used At High Areas
- Suitable Replacement Of 75W & 100W High Pressure Sodium
- Energy Saving Up To 80%



INDOOR LIGHTING

DESCRIPTION	SPECIFICATION				
Part Number	LS6RDP□-A29E3PP□	LS8RDP□-A29E3PP□	LS8RDP□-A33E3PP□	LS8RDP□-A39E3PP□	LS8RDP□-A44E3PP□
Wattage (W)	29W	29W	33W	39W	44W
Colour Rendering Index (CRI)			85 / 95		
Beam Angle			80°		
Lumen (lm)	3,500	3,500	3,700	4,000	4,250
Luminous Efficacy (lm/w)	121	121	112	103	97
Material	Fully Aluminium Die Cast + Aluminium Reflector + Polycarbonate (PC) Milky Diffuser				
Dimension (mm)	Ø: 190 x H: 110		Ø: 220 x H: 125		
Cut Hole Size (mm)	170		200		
Weight (gm)	675		1000		
Ingress Protection (IP)			IP20 / IP44		
Lifespan (hrs)	50,000				
Driver	External - Non Dimming / Dimming 1-10V, Phase Cut, DALI				
Input Voltage	220-240Vac (50/60 Hz)				
Power Factor (PF)	> 0.90				
Total Harmonic Distortion (THD)	< 20%				

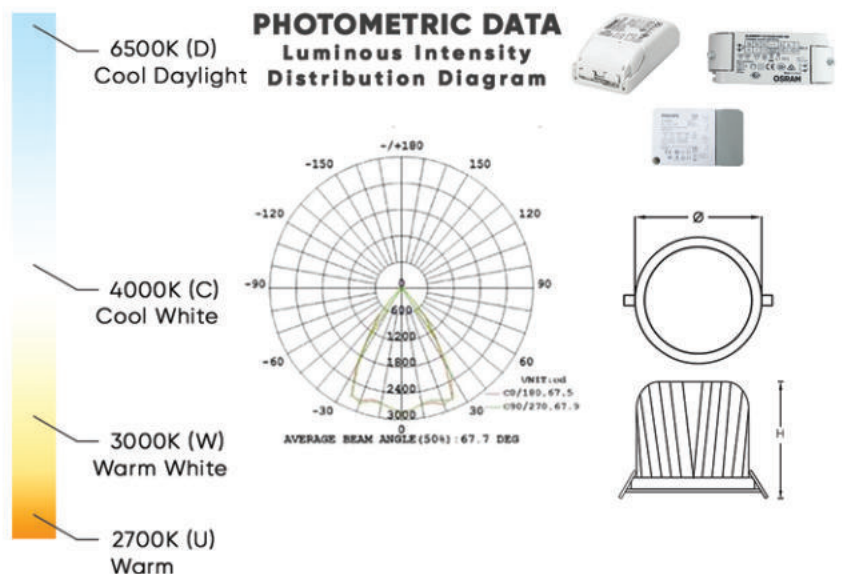

✉ sales@ligled.com.my

☎ +606-3365 696

☎ +6016-771 5697

LIGLED.COM.MY

f /LIGLED

Suruhanjaya Tenaga
Energy Commission

MADE IN MALAYSIA

RoHS

COMPLIANT

CB

LED SPOT DOWN LIGHT (ECO PREMIERE SERIES)

KEY FEATURES

- Beam Angle Selection
- High Quality & High Intensity Light With Anti-Glare Design
- Energy Saving Up To 80%
- High Efficiency > 90%
- Super Slim Casing With Higher Watt

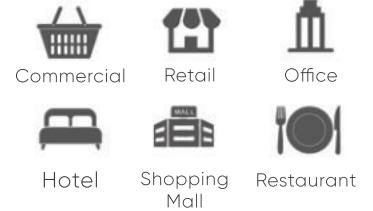

DESCRIPTION	SPECIFICATION				
Part Number	LS3RP□-A08C□□□□	LS4RP□-A15C□□□□	LS6RP□-A19C□□□□	LS7RP□-A28C□□□□	LS8RP□-A36C□□□□
Wattage (W)	8W	15W	19W	28W	36W
Colour Rendering Index (CRI)	85 / 95				
Beam Angle	15° / 25° / 40° / 60°				
Lumen (lm)	750	1,400	1,850	2,600	3,300
Luminous Efficacy (lm/w)	93	93	97	93	94
Material	Aluminium Die Cast + Polycarbonate (PC) Clear Diffuser				
Dimension (mm)	Ø: 110 x H: 125	Ø: 140 x H: 160	Ø: 160 x H: 160	Ø: 180 x H: 160	Ø: 200 x H: 180
Cut Hole Size (mm)	95	125	145	165	185
Weight (gm)	570	740	940	1100	1300
Ingress Protection (IP)			IP20 / IP44		
Lifespan (hrs)	50,000				
Driver	External - Non Dimming / Dimming 1-10V, Phase Cut, DALI				
Input Voltage	220-240Vac (50/60 Hz)				
Power Factor (PF)	> 0.90				
Total Harmonic Distortion (THD)	< 20%				

INDOOR LIGHTING

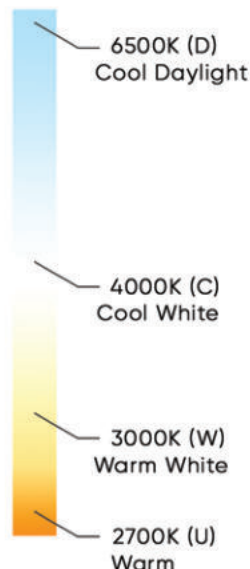
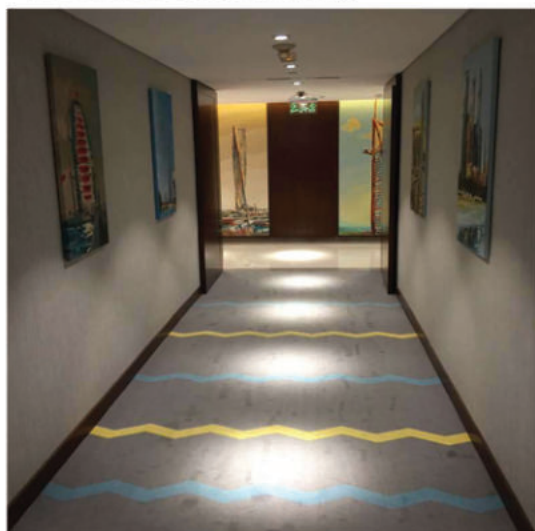

PHOTOMETRIC DATA Luminous Intensity Distribution Diagram

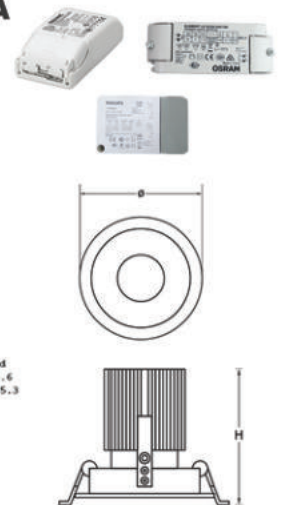
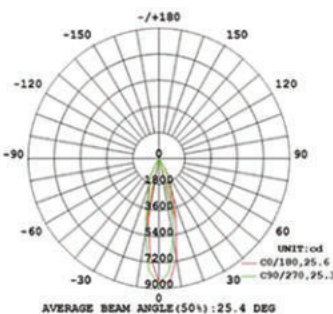

✉ sales@ligled.com.my

☎ +606-3365 696

☎ +6016-771 5697

LIGLED.COM.MY

/LIGLED

Suruhanjaya Tenaga
Energy Commission

MS

MADE IN MALAYSIA

CE

RoHS
COMPLIANT

CB 28

LED MODULE DOWN LIGHT (ECO MASTER/PREMIERE SERIES)

KEY FEATURES

- Suitable Replacement of MR16 Halogen 50W
- Beam Angle Selection (15° / 25° / 40°)
- High Quality Light
- High CRI
- No UV Or IR Light Radiation
- Energy Saving Up To 80%

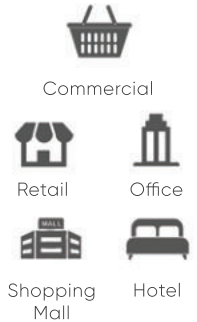

INDOOR LIGHTING

DESCRIPTION	SPECIFICATION			
Round Part Number	LMD00R0-A05C00P0	LMD00R0-A08C00P0	LMD00R0-A10C00P0	LMD00R0-A15C00P0
Square Part Number	LMD00S0-A05C00P0	LMD00S0-A08C00P0	LMD00S0-A10C00P0	LMD00S0-A15C00P0
Wattage (W)	5W	8W	10W	15W
Colour Rendering Index (CRI)	85 / 95			
Beam Angle	15° / 25° / 40°			
Lumen (lm)	450	700	900	1,350
Luminous Efficacy (lm/w)	90	88	90	90
Material	Fully Aluminium Die Cast + Polycarbonate (PC) Clear Diffuser			
Housing Dimension (mm)	Ø: 70 x H: 70	Ø: 90 x H: 70	Ø: 110 x H: 130	L: 100 x W: 100 x H: 90
Cut Hole Size (mm)	60	75	95	90 x 90
Weight (gm)	250	280	570	350
Ingress Protection (IP)	IP20 / IP44			
Lifespan (hrs)	50,000			
Driver	External - Non Dimming / Dimming 1-10V, Phase Cut, DALI			
Input Voltage	220-240Vac (50/60 Hz)			
Power Factor (PF)	> 0.90			
Total Harmonic Distortion (THD)	< 20%			
LED Module Dimension (mm)	Ø: 50 x H: 50		Ø: 50 x H: 70	

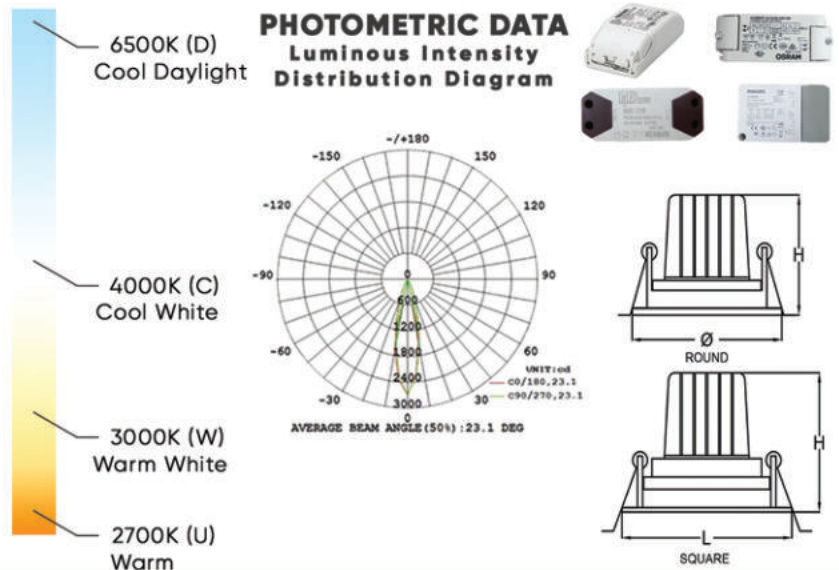

✉ sales@ligled.com.my

☎ +606-3365 696

☎ +6016-771 5697

LIGLED.COM.MY

/LIGLED



LED AR111 MODULE (ECO MASTER/PREMIERE SERIES)

KEY FEATURES

- Suitable Replacement Of 50W, 75W 100W Halogen Lamps
- Precise Light Control
- Produces 4 Times The Concentrated Light Intensity
- Energy Saving Up To 80%



Retail



Office



Shopping Mall



Hotel

INDOOR LIGHTING

DESCRIPTION	SPECIFICATION			
Part Number	LAR111G□-A10C□□□	LAR111G□-A15C□□□	LAR111G□-A19C□□□	LAR111G□-A28C□□□
Wattage (W)	10W	15W	19W	28W
Colour Rendering Index (CRI)	85 / 95			
Beam Angle	15° / 25° / 40°			
Lumen (lm)	1,000	1,500	1,900	2,800
Luminous Efficacy (lm/w)	100	100	100	100
Material	Aluminium with Die Cast Housing + Polycarbonate (PC) Clear Diffuser			
Dimension (mm)	Ø: 111 x H: 50			
Weight (gm)	400			
Ingress Protection (IP)	IP20 / IP44			
Lifespan (hrs)	50,000			
Driver	External - Non Dimming / Dimming 1-10V, Phase Cut, DALI			
Input Voltage	220-240Vac (50/60 Hz)			
Power Factor (PF)	> 0.90			
Total Harmonic Distortion (THD)	< 20%			

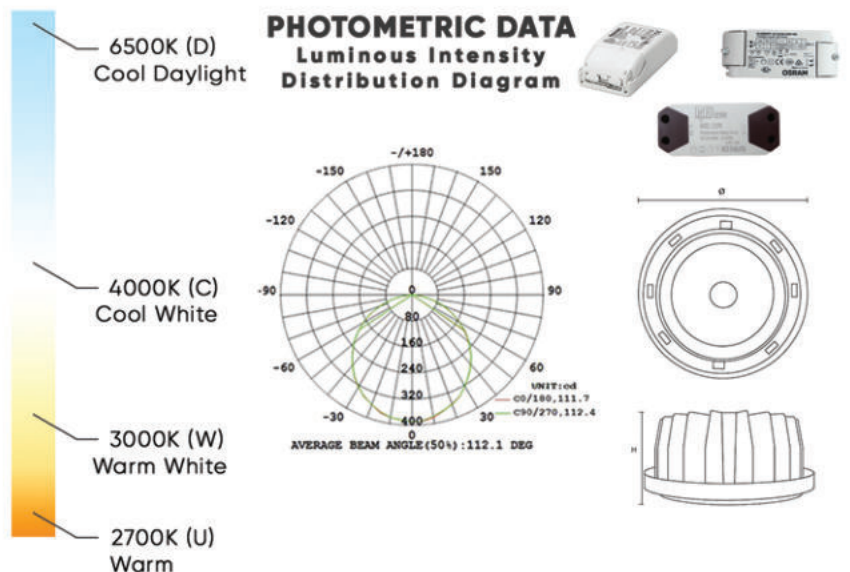

✉ sales@ligled.com.my

☎ +606-3365 696

☎ +6016-771 5697

LIGLED.COM.MY

/LIGLED



30

LED CYLINDRICAL SURFACE DOWN LIGHT (ELEGANCE SERIES)

KEY FEATURES

- Stylish & Unique Looking Design
- Perfect Used For Architectural Lighting
- For Interior & Exterior Decoration
- With Difference Beam Angle 15° / 25° / 40° / 60°
- Provide Uniform Lighting Effect



Hotel



Retail



Office



Shopping Mall



Commercial



Residential

INDOOR LIGHTING

DESCRIPTION	SPECIFICATION			
Part Number	LCSD315R□-E08C□□□	LCSD315R□-E12C□□□	LCSD420R□-E15C□□□	LCSD518R□-E19C□□□
Wattage (W)	8W	12W	15W	19W
Colour Rendering Index (CRI)	85 / 95			
Beam Angle	15° / 25° / 40° / 60°			
Lumen (lm)	760	1,100	1,400	1,800
Luminous Efficacy (lm/w)	95	92	93	95
Material	Aluminium + Clear Glass Diffuser			
Dimension (mm)	Ø: 100 x H: 155		Ø: 120 x H: 200	
Weight (gm)	780		880	
Ingress Protection (IP)	IP20 / IP44			
Lifespan (hrs)	50,000			
Driver	Internal - Non Dimming			
Input Voltage	220-240Vac (50/60 Hz)			
Power Factor (PF)	> 0.90			
Total Harmonic Distortion (THD)	< 20%			

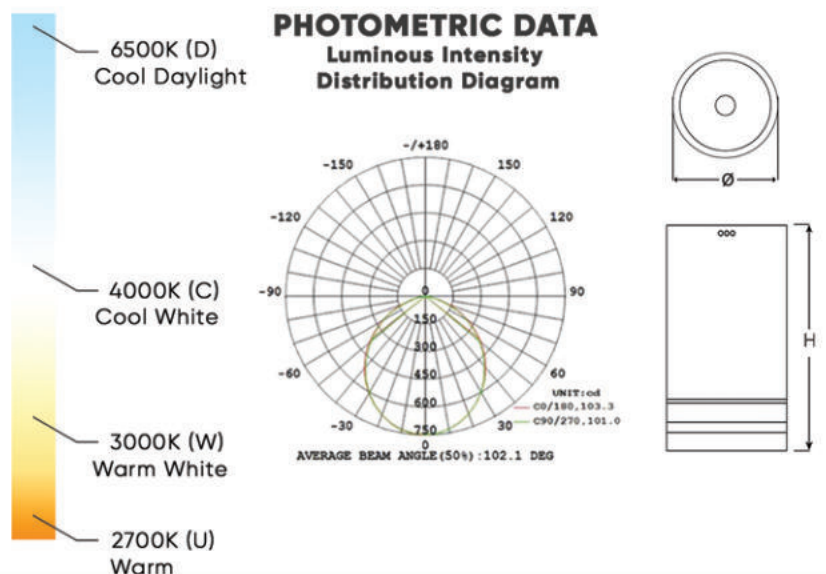

✉ sales@ligled.com.my

☎ +606-3365 696

☎ +6016-771 5697

LED SURFACE DOWN LIGHT ROUND (RIGID SERIES)

KEY FEATURES

- Stylish Design
- Easy And Low Maintenance
- Fully Aluminum Die Cast Casing
- Long Life Cycles
- Provide Uniform Lighting Effect



INDOOR LIGHTING

DESCRIPTION	SPECIFICATION			
Part Number	LSD4RCS-R12E3P□	LSD6RCS-R12E3P□	LSD6RCS-R18E3P□	LSD8RCS-R22E3P□
Wattage (W)	12W	12W	18W	22W
Colour Rendering Index (CRI)	85			
Beam Angle	120°			
Lumen (lm)	1,200	1,200	1,800	2,200
Luminous Efficacy (lm/w)	100	100	100	100
Material	Aluminium + Polycarbonate (PC) Milky Diffuser			
Dimension (mm)	Ø: 120 x H: 80	Ø: 170 x H: 100	Ø: 215 x H: 210	
Weight (gm)	450	680	900	
Ingress Protection (IP)	IP20 / IP44			
Lifespan (hrs)	50,000			
Driver	Internal - Non Dimming			
Input Voltage	220-240Vac (50/60 Hz)			
Power Factor (PF)	> 0.90			
Total Harmonic Distortion (THD)	< 12%			

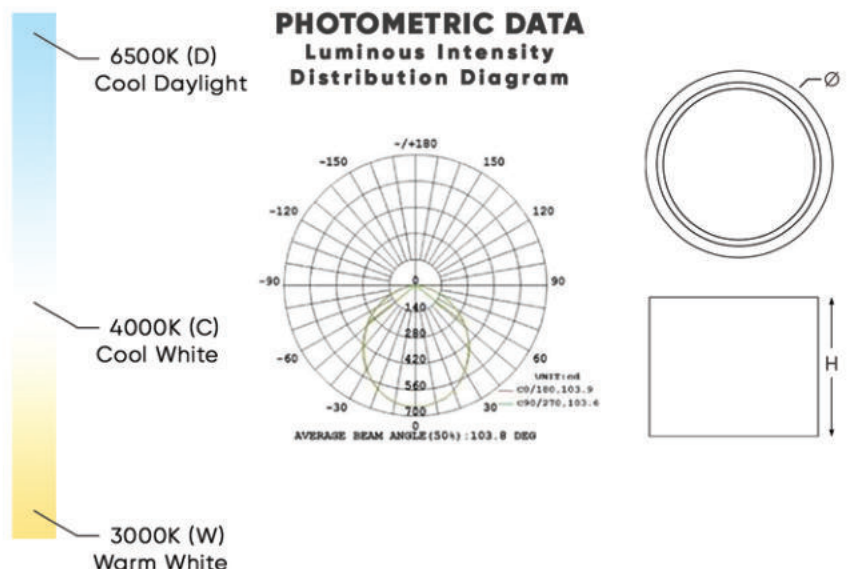

✉ sales@ligled.com.my

☎ +606-3365 696

☎ +6016-771 5697

LIGLED.COM.MY

/LIGLED

Suruhanjaya Tenaga
Energy Commission

MS

MADE IN MALAYSIA

RoHS

COMPLIANT

CB

32

LED PENDANT LIGHT (ELEGANCE SERIES)

KEY FEATURES

- Modern & Elegant Light Design
- Pendant Size Selection
- High Quality Light Intensity
- Energy Saving Up To 80%



INDOOR LIGHTING

DESCRIPTION	SPECIFICATION			
Part Number	LPL1015CS-A08C□□□□	LPL1015CS-A12C□□□□	LPL0816CT-A15C□□□□	LPL0816CT-A19C□□□□
Wattage (W)	8W	12W	15W	19W
Colour Rendering Index (CRI)	85 / 95			
Beam Angle	15° / 25° / 40° / 60°			
Lumen (lm)	760	1,100	1,400	1,800
Luminous Efficacy (lm/w)	95	92	93	95
Material	Aluminium + Polycarbonate (PC) Diffuser / Glass Diffuser			
Dimension (mm)	Ø: 100 x H: 155 + 1m Suspension Wire		Ø: 80 x H: 162 + 1m Suspension Wire	
Weight (gm)	400		450	
Ingress Protection (IP)			IP20 / IP44	
Lifespan (hrs)	50,000			
Driver	Internal / External - Non Dimming			
Input Voltage	220-240Vac (50/60 Hz)			
Power Factor (PF)	> 0.90			
Total Harmonic Distortion (THD)	< 20%			

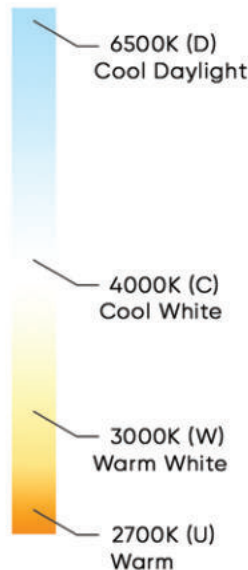

PHOTOMETRIC DATA Luminous Intensity Distribution Diagram

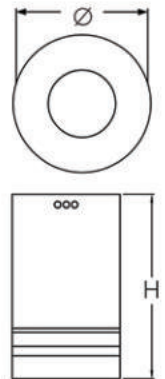
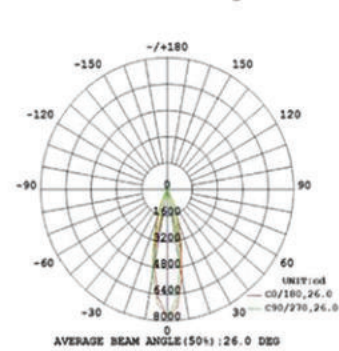

✉ sales@ligled.com.my

☎ +606-3365 696

☎ +6016-771 5697

LIGLED.COM.MY

/LIGLED

Suruhanjaya Tenaga
Energy Commission

MS

MAJLIS BERNAMA
MADE IN MALAYSIA

SGS

RoHS

RoHS COMPLIANT

CB

LED TRACK LIGHT (ECO MASTER/PREMIERE SERIES)

KEY FEATURES

- Easy Installation
- Perfect Use For Interior Lighting Decoration
- 360° Rotation Adjustable
- Multiple Beam Angle
- Suitable Replacement Of CDMT 50W & 70W

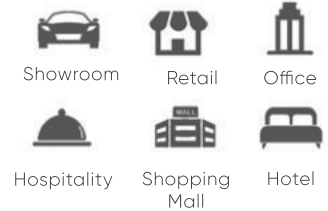

DESCRIPTION	SPECIFICATION		
Part Number	LTL310RS-A08C□□□□	LTL310RS-A10C□□□□	LTL313RS-A12C□□□□
Wattage (W)	8W	10W	12W
Colour Rendering Index (CRI)	85 / 95		
Beam Angle	15° / 25° / 40°		
Lumen (lm)	650	800	1,000
Luminous Efficacy (lm/w)	82	80	83
Material	Aluminium + Polycarbonate (PC) Diffuser		
Dimension (mm)	Ø: 75 x H: 180	Ø: 75 x H: 210	
Weight (gm)	310	470	
Ingress Protection (IP)	IP20		
Lifespan (hrs)	50,000		
Driver	Internal - Non Dimming		
Input Voltage	220-240Vac (50/60 Hz)		
Power Factor (PF)	> 0.90		
Total Harmonic Distortion (THD)	< 20%		

INDOOR LIGHTING

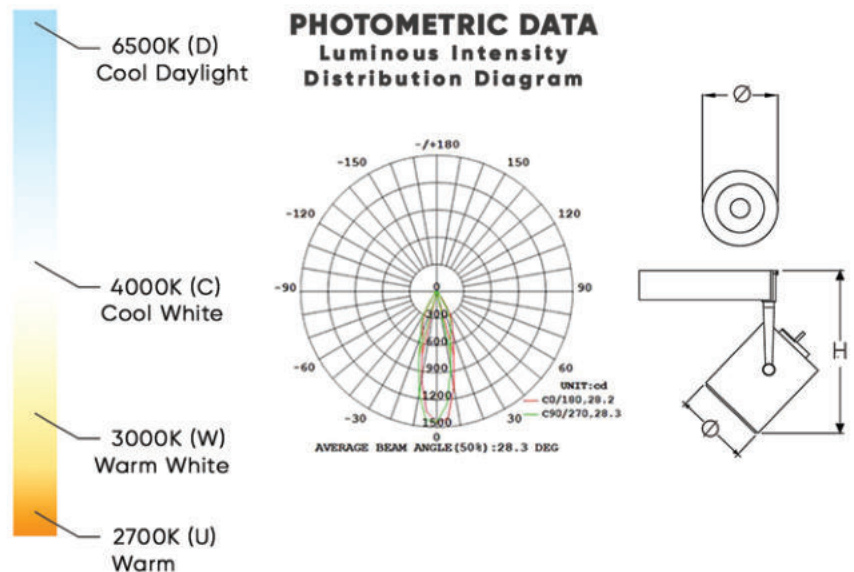

✉ sales@ligled.com.my

☎ +606-3365 696

☎ +6016-771 5697

LIGLED.COM.MY



/LIGLED



CB 34

INDUSTRIAL LIGHTING

LED WEATHERPROOF BATTEN (MASTER SERIES)

KEY FEATURES

- Used For Superior Safety
- Replacement For Conventional Fluorescent Classification Weatherproof Luminaires
- Perfect Design For Weatherproof Protection
- Easy Replacement For T8 LED Tube



DESCRIPTION	SPECIFICATION			
Part Number	LWPC812□E-□09E3□M□	LWPC822□E-□09E3□M□	LWPC814□E-□16E3□M□	LWPC824□E-□16E3□M□
Wattage (W)	1 x 9W	2 x 9W	1 x 16W	2 x 16W
Colour Rendering Index (CRI)	85			
Beam Angle	120°			
Lumen (lm)	1,300	2,600	2,300	4,600
Luminous Efficacy (lm/w)	145	144	144	144
Material	Body: Polycarbonate (PC) + Prismatic Polycarbonate (PC) Diffuser + Stainless Steel Clips (Weatherproof)			
Dimension (mm)	L: 670 x W: 110 x H: 110	L: 670 x W: 160 x H: 110	L: 1270 x W: 110 x H: 110	L: 1270 x W: 160 x H: 110
Weight (gm)	1050	1350	1600	1800
Dimension: T8 LED Tube (mm)	Ø: 26 x L: 600		Ø: 26 x L: 1200	
Ingress Protection (IP)	IP65			
Lifespan (hrs)	50,000			
Driver	Internal - Non Dimming			
Input Voltage	220-240Vac (50/60 Hz)			
Power Factor (PF)	0.95			
Total Harmonic Distortion (THD)	< 12%			

INDUSTRIAL LIGHTING

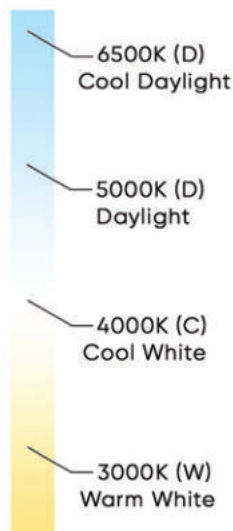

PHOTOMETRIC DATA Luminous Intensity Distribution Diagram

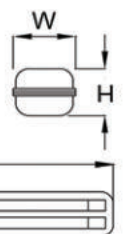
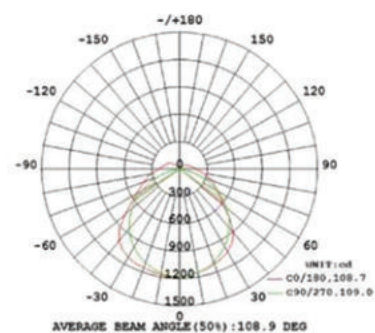

✉ sales@ligled.com.my

☎ +606-3365 696

☎ +6016-771 5697



LIGLED.COM.MY



/LIGLED



36

LED WEATHERPROOF LINEAR BATTEN (ECO MASTER SERIES)

KEY FEATURES

- Perfect Design For Superior Safety
- Replacement For Conventional Fluorescent Classifications Weatherproof Luminaires
- Used For Weatherproof Protection
- Suitable To Use At Clean Room
- Build In Linear LED Module



Industrial



Warehouse

DESCRIPTION	SPECIFICATION		
Part Number	LWLB2S-P20E3M□	LWLB4S-P20E3M□	LWLB4S-P40E3M□
Wattage (W)	20W	20W	40W
Colour Rendering Index (CRI)	85		
Beam Angle	120°		
Lumen (lm)	2,200	2,200	4,400
Luminous Efficacy (lm/w)	110	110	110
Material	Solid Fully Polycarbonate (PC) + Milky Diffuser + Stainless Steels Hocks		
Dimension (mm)	L: 600 x W: 80 x H: 77	L: 1200 x W: 80 x H: 77	
Weight (gm)	700	1450	
Ingress Protection (IP)	IP65		
Lifespan (hrs)	50,000		
Driver	Internal - Non Dimming		
Input Voltage	220-240Vac (50/60 Hz)		
Power Factor (PF)	> 0.90		
Total Harmonic Distortion (THD)	< 12%		

INDUSTRIAL LIGHTING

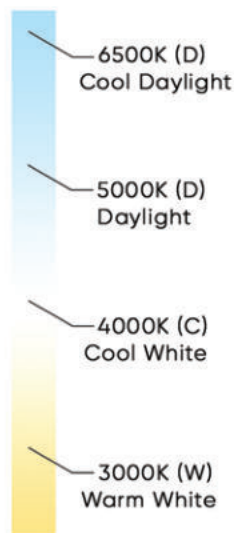

PHOTOMETRIC DATA Luminous Intensity Distribution Diagram

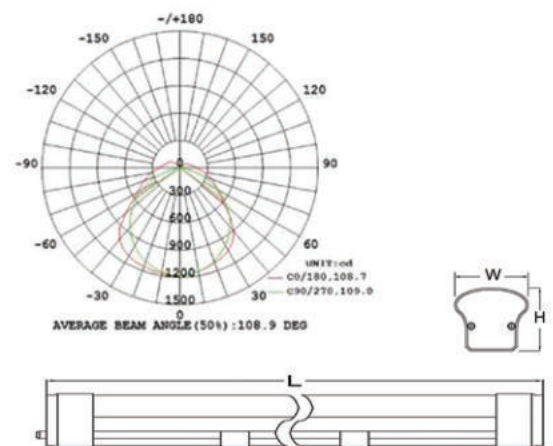

✉ sales@ligled.com.my

☎ +606-3365 696

☎ +6016-771 5697



LIGLED.COM.MY



/LIGLED



E27 LED HIGH POWER BULB LIGHT (ECO ELITE MASTER SERIES)

KEY FEATURES

- Suitable Replacement Of 75W Sodium Lamp
- Easy & Low Maintenance
- Provide High Lumen Output
- Lamp Base: E27



DESCRIPTION	SPECIFICATION		
Part Number	LBHPE27-A12E3EP□	LBHPE27-A20E3EP□	LBHPE27-A30E3EP□
Wattage (W)	12W	20W	30W
Colour Rendering Index (CRI)	85		
Beam Angle	120°		
Lumen (lm)	1,400	2,450	3,500
Luminous Efficacy (lm/w)	117	123	117
Material	Aluminium Die Cast + Polycarbonate (PC) Milky Diffuser		
Dimension (mm)	Ø: 84 x H: 135	Ø: 120 x H: 180	Ø: 145 x H: 180
Weight (gm)	270	295	430
Lamp Base	E27		
Ingress Protection (IP)	IP20		
Lifespan (hrs)	35,000		
Driver	Internal - Non Dimming		
Input Voltage	220-240Vac (50/60 Hz)		
Power Factor (PF)	> 0.90		
Total Harmonic Distortion (THD)	< 12%		

INDUSTRIAL LIGHTING

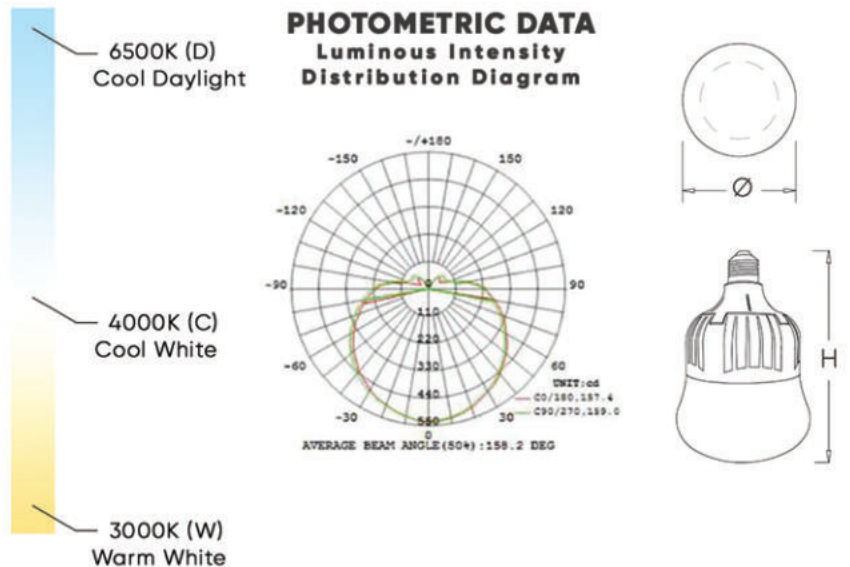

✉ sales@ligled.com.my

☎ +606-3365 696

☎ +6016-771 5697

🌐 LIGLED.COM.MY

📘 /LIGLED



E27 LED HIGH POWER BULB (ECO MASTER SERIES)

KEY FEATURES

- Suitable Replacement of 75W Sodium Lamps
- Easy And Low Maintenance
- High Lumen Output
- Perfect Use For Industrial Lighting Decoration
- Lamp Base: E27



INDUSTRIAL LIGHTING

DESCRIPTION	SPECIFICATION		
Part Number	LBHPE27-A12E3PP□	LBHPE27-A20E3PP□	LBHPE27-A30E3PP□
Wattage (W)	12W	20W	30W
Colour Rendering Index (CRI)	85		
Beam Angle	120°		
Lumen (lm)	1,800	3,200	4,500
Luminous Efficacy (lm/w)	150	160	150
Material	Aluminium Die Cast + Polycarbonate (PC) Milky Diffuser		
Dimension (mm)	Ø: 70 x H: 155	Ø: 100 x H: 180	Ø: 120 x H: 210
Weight (gm)	270	290	430
Lamp Base	E27		
Ingress Protection (IP)	IP54		
Lifespan (hrs)	50,000		
Driver	Internal - Non Dimming		
Input Voltage	220-240Vac (50/60 Hz)		
Power Factor (PF)	> 0.90		
Total Harmonic Distortion (THD)	< 12%		

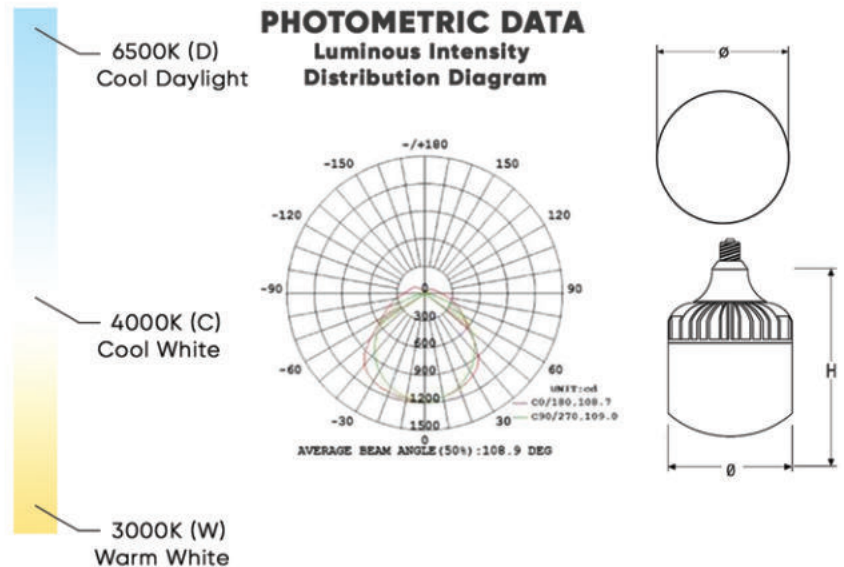
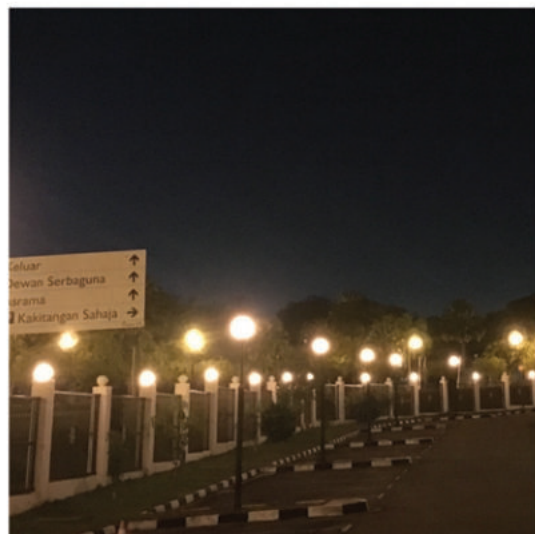

✉ sales@ligled.com.my

☎ +606-3365 696

☎ +6016-771 5697

LIGLED.COM.MY

/LIGLED



LED LOW & HIGH BAY (ECO PREMIUM SERIES)

KEY FEATURES

- Suitable Replacement of 250W & 400W Metal Halide
- Solid Die Cast Aluminum Material
- Easy Heat Dissipation
- Long Product Lifespan
- Energy Saving Up To 80%



DESCRIPTION	SPECIFICATION			
Part Number	LLBCP-A080N3G□	LLBCP-A100N3G□	LHBCP-A140N3G□	LHBCP-A180N3G□
Wattage (W)	80W	100W	140W	180W
Colour Rendering Index (CRI)	80			
Beam Angle	120°			
Lumen (lm)	11,000	13,500	19,000	24,500
Luminous Efficacy (lm/w)	138	135	136	136
Material	Aluminium Die Cast + Clear Glass Diffuser (Option: Reflector)			
Dimension (mm)	Ø: 280 x L: 210		Ø: 325 x L: 225	
Weight (gm)	2000		4000	4500
Lamp Base	Hook Type			
Ingress Protection (IP)	IP65			
Lifespan (hrs)	50,000			
Driver	External - Non Dimming / Dimming -1 -10V			
Input Voltage	100-240Vac (50/60 Hz)			
Power Factor (PF)	> 0.90			
Total Harmonic Distortion (THD)	< 15%			

INDUSTRIAL LIGHTING

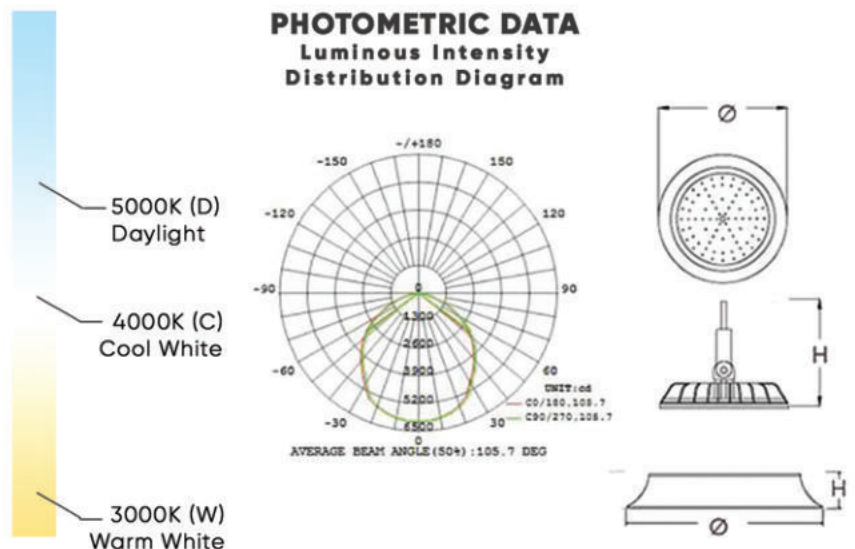
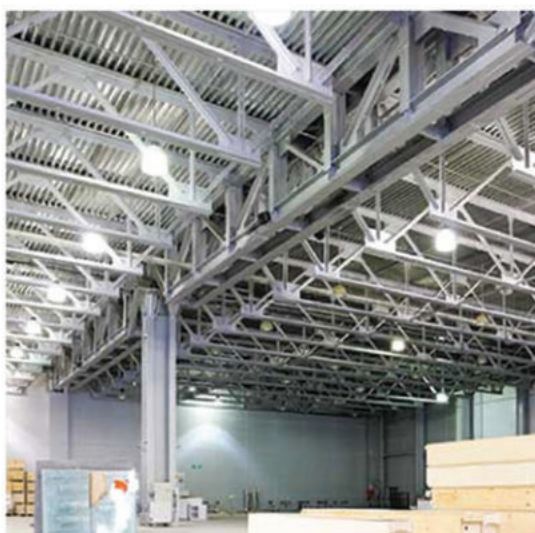

✉ sales@ligled.com.my

☎ +606-3365 696

☎ +6016-771 5697



LIGLED.COM.MY



/LIGLED



40

OUTDOOR LIGHTING

LED SLIM FLOOD LIGHT (ECO PREMIUM SERIES)

KEY FEATURES

- Slim & Elegant Design
- Wide Coverage Angle
- To Replace Of 75W-400W Of Sodium & Metal Halide
- Less Heat Produced
- Good Quality LED

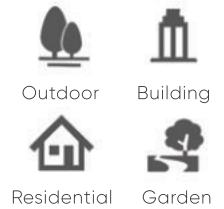

DESCRIPTION	SPECIFICATION				
Part Number	LFLCP-A050N3G□	LFLCP-A070N3G□	LFLCP-A100N3G□	LFLCP-A140N3G□	LFLCP-A180N3G□
Wattage (W)	50W	70W	100W	140W	180W
Colour Rendering Index (CRI)	85				
Beam Angle	120°				
Lumen (lm)	6,500	9,000	13,000	19,000	24,000
Luminous Efficacy (lm/w)	130	128	130	136	133
Material	Slim Aluminium Die Cast + Tempered Glass Diffuser				
Dimension (mm)	L: 265 x W: 220 x H: 55 L: 300 x W: 245 x H: 55 L: 345 x W: 295 x H: 55 L: 365 x W: 330 x H: 55 L: 400 x W: 360 x H: 55				
Weight (gm)	2000	3800	4500	6500	8500
Ingress Protection (IP)	IP65				
Lifespan (hrs)	50,000				
Driver	Internal - Non Dimming + Surge Protection Device (SPD)				
Input Voltage	100-240Vac (50/60 Hz)				
Power Factor (PF)	> 0.90				
Total Harmonic Distortion (THD)	< 15%				

OUTDOOR LIGHTING

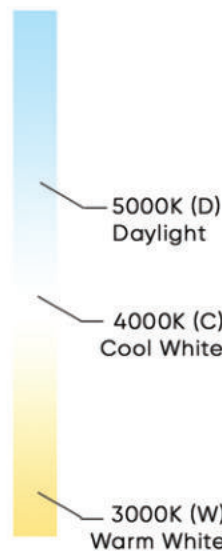
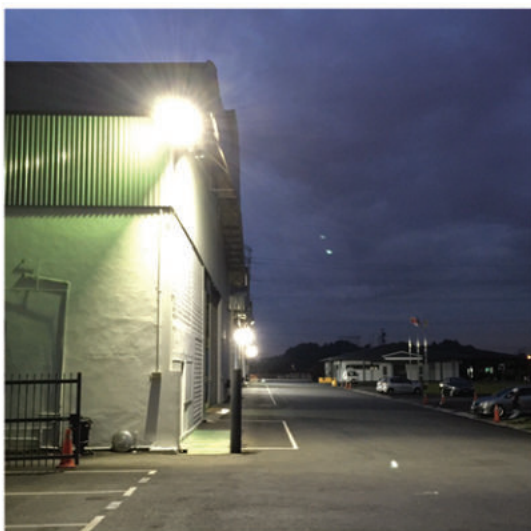

PHOTOMETRIC DATA Luminous Intensity Distribution Diagram

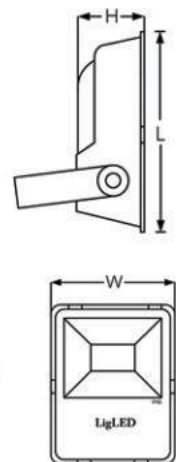
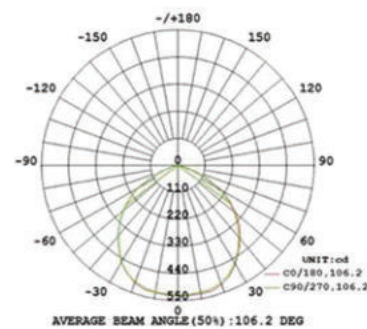

✉ sales@ligled.com.my

☎ +606-3365 696

☎ +6016-771 5697

🌐 LIGLED.COM.MY

📘 /LIGLED



LED BULK HEAD LIGHT (ECO ELEGANT SERIES)

KEY FEATURES

- Selection Of Indoor And Outdoor Wall Pattern
- From Traditional To Colonial And Architectural Lighting
- Application At Entrance, Corridor And External Wall Of Buidings



DESCRIPTION	SPECIFICATION			
Part Number	LBH6R□-A12E3P□	LBH8R□-A18E3P□	LBH12R□-A20E3P□	LBH14R□-A30E3P□
Wattage (W)	12W	18W	20W	30W
Colour Rendering Index (CRI)	85			
Beam Angle	120°			
Lumen (lm)	1,200	1,800	2,000	3,000
Luminous Efficacy (lm/w)	100	100	100	100
Material	Aluminium Die Cast + Glass / Polycarbonate (PC) Diffuser			
Dimension (mm)	Ø: 145 x H: 65	Ø: 230 x H: 80	Ø: 280 x H: 90	Ø: 360 x H: 130
Weight (gm)	800	1000	1200	1500
Ingress Protection (IP)	IP65			
Lifespan (hrs)	50,000			
Driver	Internal - Non Dimming / Dimming 1-10V, Phase Cut, DALI			
Input Voltage	220-240Vac (50/60 Hz)			
Power Factor (PF)	0.85			
Total Harmonic Distortion (THD)	< 12%			

OUTDOOR LIGHTING

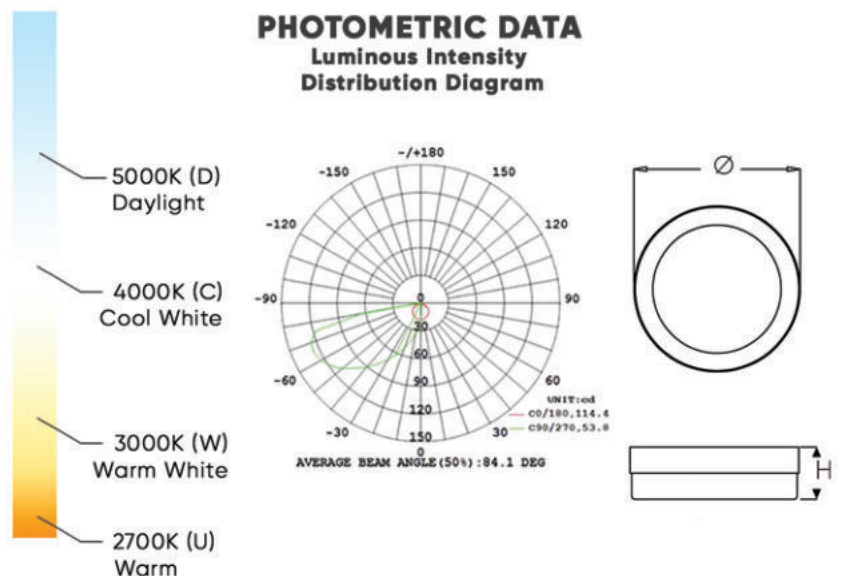

✉ sales@ligled.com.my

☎ +606-3365 696

☎ +6016-771 5697

LIGLED.COM.MY

/LIGLED



LED STREET LIGHT (ECO PREMIUM SERIES)

KEY FEATURES

- Street Light With Nema Socket For Dimming & Smart Control Lighting
- To Replacement Of 150W-400W Sodium & Metal Halide
- Dynamic Design To Prevent Wind And Dust
- High Energy Saving > 60%
- Excellent Heat Dissipation



DESCRIPTION	SPECIFICATION					
Part Number	LSTLCP-A60N5G□	LSTLCP-A95N5G□	LSTLCP-A120N5G□	LSTLCP-A150N5G□	LSTLCP-A180N5G□	LSTLCP-A200N5G□
Wattage (W)	60W	95W	120W	150W	180W	200W
Colour Rendering Index (CRI)	70					
Beam Angle	120°					
Lumen (lm)	9,000	14,500	18,500	23,000	27,000	29,500
Luminous Efficacy (lm/w)	150	153	154	153	150	148
Material	Pure Aluminium Die Cast with Clear Tempered Glass Diffuser					
Dimension (mm)	L: 630 x W: 270 x H: 155			L: 780 x W: 300 x H: 155		
Weight (gm)	6000			8000		
Ingress Protection (IP)	IP66					
Lifespan (hrs)	50,000					
Driver	Internal - Non Dimming / Dimming 1-10V + Surge Protection Device (SPD)					
Input Voltage	100-240Vac (50/60 Hz)					
Power Factor (PF)	0.85					
Total Harmonic Distortion (THD)	< 12%					
NEMA Socket	7-Pin Nema ANSI Connector: Support LEMS, LORA, NB-IOT Smart Lighting System (Optional)					

OUTDOOR LIGHTING

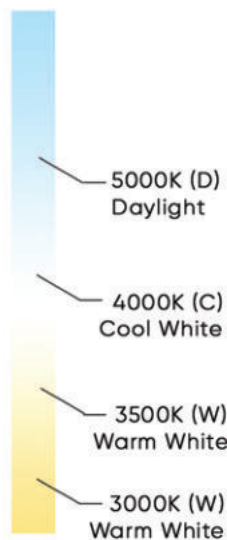

PHOTOMETRIC DATA Luminous Intensity Distribution Diagram

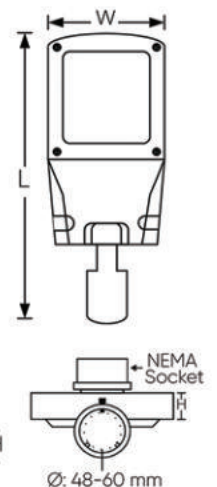
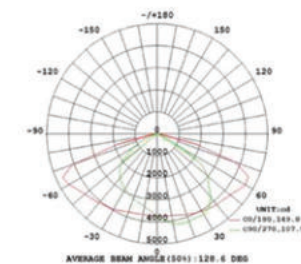

✉ sales@ligled.com.my

☎ +606-3365 696

☎ +6016-771 5697

🌐 LIGLED.COM.MY

📘 /LIGLED



LED STREET LIGHT (PREMIUM SERIES)

KEY FEATURES

- Suitable Replacement Of 150W-400W Sodium & Metal Halide Lamps
- Using Fin Technology For Fast Heat Dissipation
- High Energy Savings > 80%
- Longer Life Cycles



DESCRIPTION	SPECIFICATION			
Part Number	LSTLW-A040NL□	LSTLW-A060NL□	LSTLW-A090NL□	LSTLW-A120NL□
Wattage (W)	40W	60W	90W	120W
Colour Rendering Index (CRI)	70			
Beam Angle	120°			
Lumen (lm)	5,500	8,700	12,600	17,000
Luminous Efficacy (lm/w)	138	145	140	142
Material	Pure Aluminium Fin + Polycarbonate (PC) Lens Diffuser			
Dimension (mm)	L: 375 x W: 200 x H: 60	L: 500 x W: 295 x H: 65	L: 500 x W: 295 x H: 65	L: 590 x W: 295 x H: 65
Weight (gm)	2800	5500	5500	7300
Ingress Protection (IP)	IP66			
Lifespan (hrs)	50,000			
Driver	Internal - Non Dimming + Surge Protection Device (SPD)			
Input Voltage	100-240Vac (50/60 Hz)			
Power Factor (PF)	0.95			
Total Harmonic Distortion (THD)	< 12%			

OUTDOOR LIGHTING

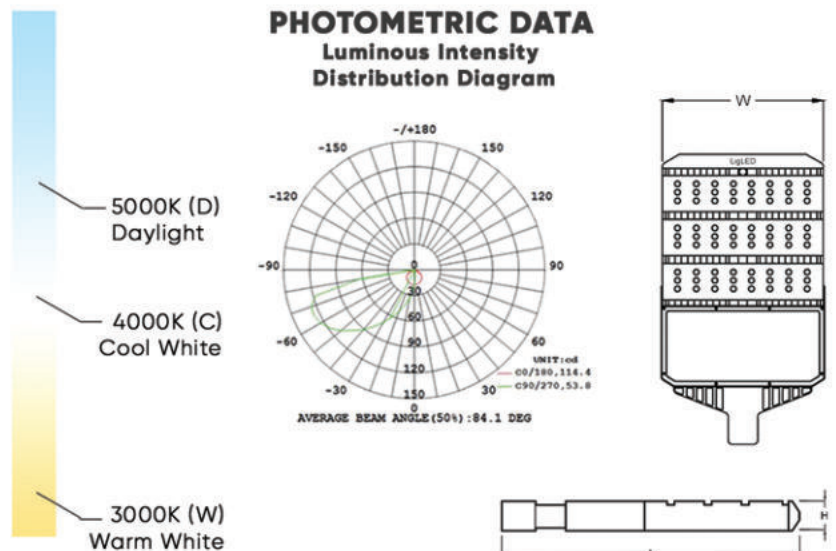

✉ sales@ligled.com.my

☎ +606-3365 696

☎ +6016-771 5697

LIGLED.COM.MY

/LIGLED



LED HIGH MAST/FLOOD LIGHT/HIGH BAY (PREMIUM SERIES)

KEY FEATURES

- Suitable Replacement Of 250W-2000W Metal Halide Lamps
- Designed To Deliver High Lumen Output
- Solid Die Cast Aluminium With High Good Heat Dissipation
- Energy Saving Up To 80%



DESCRIPTION	SPECIFICATION					
Part Number	LHMLP-A100N5G□	LHMLP-A200N5G□		LHMLP-A400N5G□		
		LHMLP-A150N5G□	LHMLP-A300N5G□	LHMLP-A450N5G□		
Wattage (W)	100W	150W	200W	300W	400W	450W
Colour Rendering Index (CRI)	70					
Beam Angle	30° / 60° / 90° / 120°					
Lumen (lm)	14,500	22,500	30,000	43,500	58,000	65,000
Luminous Efficacy (lm/w)	145	150	150	145	145	144
Material	Pure Aluminium Die Cast with Clear Tempered Glass Diffuser					
Dimension (mm)	L: 330 x W: 200 x H: 175	L: 440 x W: 235 x H: 190		L: 560 x W: 330 x H: 245		
Weight (gm)	4500	6500		11500		
Ingress Protection (IP)	IP66					
Lifespan (hrs)	50,000					
Driver	External - Non Dimming / Dimming 1-10V + Surge Protection Device (SPD)					
Input Voltage	100-240Vac (50/60 Hz)					
Power Factor (PF)	> 0.90					
Total Harmonic Distortion (THD)	< 12%					

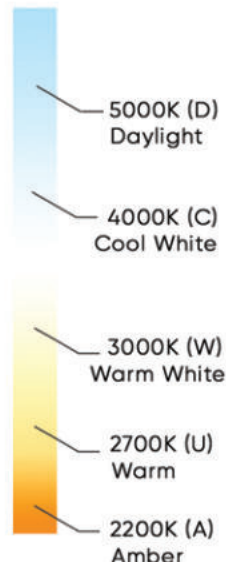

PHOTOMETRIC DATA

Luminous Intensity Distribution Diagram

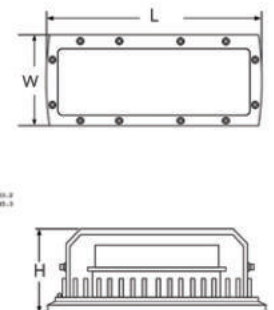
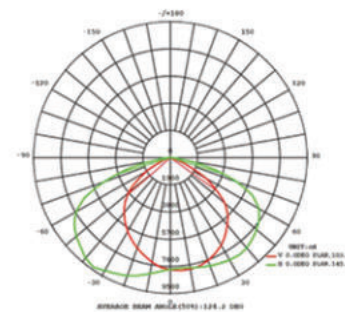

OUTDOOR LIGHTING

✉ sales@ligled.com.my

☎ +606-3365 696

☎ +6016-771 5697

🌐 LIGLED.COM.MY

📘 /LIGLED



LANDSCAPE LIGHTING

LED BOLLARD LIGHT (ECO ELEGANCE SERIES)

KEY FEATURES

- Selection Of Outdoor Bollard Range
- Used To Add Light & Style To Outdoor Areas
- Used At Driveway Paths, Gardens, Walkways, Parks & Residential Areas



DESCRIPTION		SPECIFICATION			
Part Number Round	LBL1206RS-A10E3P□	LBL1209RS-A15E3P□	LBL1506RS-A12E3P□	LBL1509RS-A18E3P□	
Part Number Square	LBL1206SS-A10E3P□	LBL1209SS-A15E3P□	LBL1506SS-A12E3P□	LBL1509SS-A18E3P□	
Wattage (W)	10W	15W	12W	18W	
Colour Rendering Index (CRI)	85				
Beam Angle	120°				
Lumen (lm)	900	1,400	1,100	1,680	
Luminous Efficacy (lm/w)	90	93	92	94	
Material	Aluminium Die Cast + Corrosive Epoxy Powder Coat				
Dimension (mm)	Ø: 120 x H: 600	Ø: 120 x H: 900	Ø: 150 x H: 600	Ø: 150 x H: 900	
Weight (gm)	3000	4500	3500	5500	
Ingress Protection (IP)	IP65				
Lifespan (hrs)	50,000				
Driver	Internal - Non Dimming				
Input Voltage	220-240Vac (50/60 Hz)				
Power Factor (PF)	> 0.90				
Total Harmonic Distortion (THD)	< 20%				

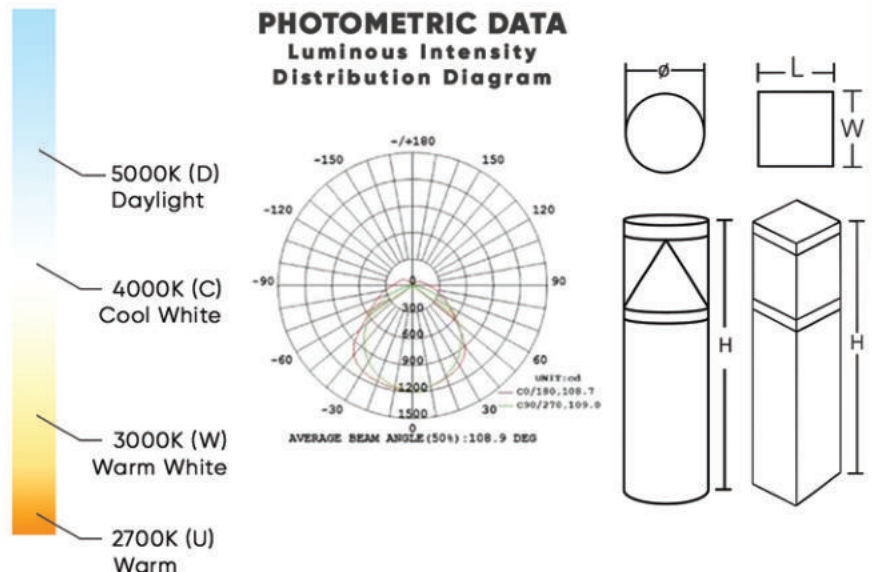

LANDSCAPE LIGHTING

✉ sales@ligled.com.my

☎ +606-3365 696

☎ +6016-771 5697

🌐 LIGLED.COM.MY

f /LIGLED



LED SPOT/SPIKE LIGHT *(ECO ELEGANT SERIES)*

KEY FEATURES

- Commonly Used In Outdoor Public Spaces
- Suitable Replacement For 50W Halogen Lamps
- Very Low Wattage With Energy Savings Up To 80%
- 90 Degree Angle Adjustment
- Option: Spike Can Be Attached



DESCRIPTION	SPECIFICATION			
Part Number	LSL01RS-A08C□□□□	LSL02RS-A12C□□□□	LSL04R□-A18C□□□□	LSK08R□-A08C□□□□
Wattage (W)	8W	12W	18W	8W
Colour Rendering Index (CRI)	85 / 95			
Beam Angle	15° / 25° / 40°			
Lumen (lm)	650	900	1,500	520
Luminous Efficacy (lm/w)	81	75	83	65
Material	Aluminium Die Cast + Tempered Glass Diffuser			
Dimension (mm)	Ø: 95 x H: 175	Ø: 85 x H: 250	Ø: 145 x H: 340	Ø: 60 x H: 355
Weight (gm)	750	690	1130	513
Ingress Protection (IP)			IP65	
Lifespan (hrs)	50,000			
Driver	Internal - Non Dimming		External - 24V Non Dimming / Dimming 1-10V	
Driver Part Number	ECOPB20		LOMW24V-□□□□	
Input Voltage	220-240Vac (50/60 Hz)		24 Vdc	
Driver Ingress Protection (IP)	IP65		IP67	

LANDSCAPE LIGHTING



PHOTOMETRIC DATA

Luminous Intensity Distribution Diagram

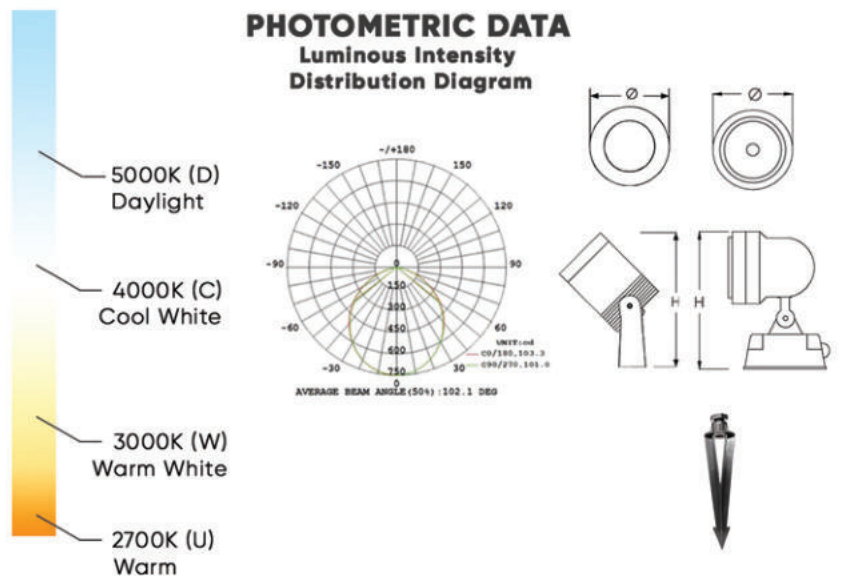

✉ sales@ligled.com.my

☎ +606-3365 696

☎ +6016-771 5697



LIGLED.COM.MY



/LIGLED



LED UPLIGHTER (ECO ELEGANT SERIES)

KEY FEATURES

- Ideal To Create A Unique And Exclusive Atmosphere Of Building & Garden
- Uplighter Is A Great Purchase To Get You Started
- This Fixture Is Fully Capable Of Colour Changing
- Product Lifespan 50,000 Hours



DESCRIPTION	SPECIFICATION			
Part Number	LUL01RS-A12N□□□□	LUL04RS-A30N□□□□	LUL06R□-A45N□□□□	LUL07R□-A80N□□□□
Wattage (W)	12W	30W	45W	80W
Colour Rendering Index (CRI)	85 / 95			
Beam Angle	15° / 25° / 40° / 60°			
Lumen (lm)	900	2,500	4,000	6,800
Luminous Efficacy (lm/w)	75	83	90	85
Material	Aluminium Die Cast + Tempered Glass Diffuser			
Dimension (mm)	Ø: 130 x H: 115	Ø: 160 x H: 180	Ø: 235 x H: 300	Ø: 285 x H: 350
Weight (gm)	800	1200	2000	3000
Ingress Protection (IP)	IP65		IP65	
Lifespan (hrs)	50,000			
Driver	Internal - Non Dimming		External - 24V Non Dimming / Dimming 1-10V	
Driver Part Number	ECOPB20		LOMW24V-□□□□	
Input Voltage	220-240Vac (50/60 Hz)		24 Vdc	
Driver Ingress Protection (IP)	IP65		IP67	

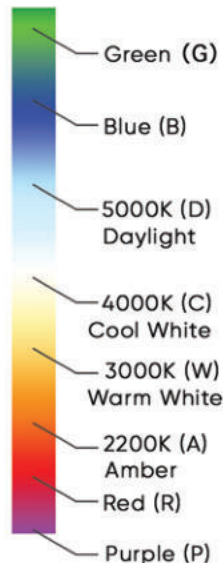

PHOTOMETRIC DATA

Luminous Intensity Distribution Diagram

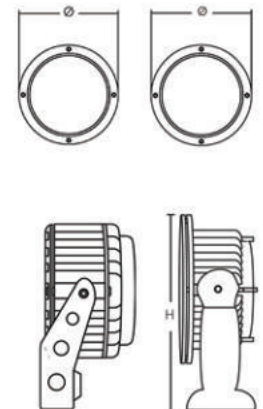
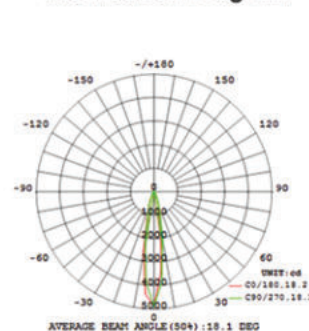

LANDSCAPE LIGHTING

✉ sales@ligled.com.my

☎ +606-3365 696

☎ +6012-345 6789



LIGLED.COM.MY



/LIGLED



LED UNDERWATER SPOT LIGHT SURFACE (ECO ELEGANT SERIES)

KEY FEATURES

- Use As An Underwater Spotlight In Fountains And Waterfalls
- Brilliance Designed For Easy Installation
- Operating Temperature: -20°C To 60°C
- Long Lifespan, Instant Start, No Flashing

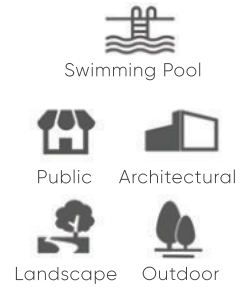

DESCRIPTION	SPECIFICATION	
Part Number	LUSL01R□E-S08N□□□	LUSL02R□E-S10N□□□
Wattage (W)	8W	10W
Colour Rendering Index (CRI)	85 / 95	
Beam Angle	25° / 30°	
Lumen (lm)	700	900
Luminous Efficacy (lm/w)	88	90
Material	Stainless Steel + Tempered Glass Diffuser	
Dimension (mm)	Ø: 82 x H: 180	Ø: 100 x H: 200
Weight (gm)	450	610
Ingress Protection (IP)	IP68	
Lifespan (hrs)	50,000	
Driver	External - Non Dimming	External - 24V Non Dimming / Dimming 1-10V
Driver Part Number	ECOPB20	LOMW24V-□□□W
Input Voltage	50 Vdc	24 Vdc
Driver Ingress Protection (IP)	IP65	IP67

LANDSCAPE LIGHTING

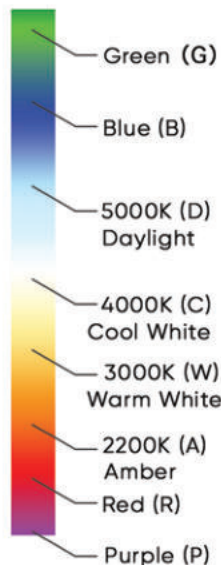

PHOTOMETRIC DATA Luminous Intensity Distribution Diagram

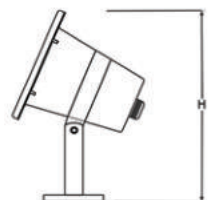
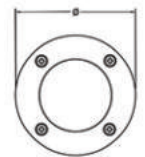
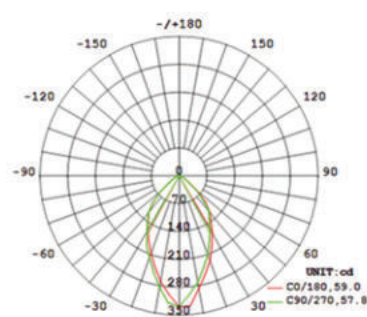

✉ sales@ligled.com.my

☎ +606-3365 696

☎ +6016-771 5697



LIGLED.COM.MY



/LIGLED

LED UNDERWATER LIGHT RECESS (ELEGANT SERIES)

KEY FEATURES

- To Be Used For Water Features Applications
- Available For Different Kinds Of Optics And Color Temperature
- Design For Low Energy Consumptions
- Longer Life Cycles



DESCRIPTION	SPECIFICATION			
Part Number	LINGUW2R24E-S02N□□□	LINGUW3R24E-S05N□□□	LINGUW6R24E-S12N□□□	LINGUW7R24E-S15N□□□
Wattage (W)	2W	5W	12W	15W
Colour Rendering Index (CRI)	85 / 95			
Beam Angle	15° / 25° / 40° / 60°			
Lumen (lm)	120	280	750	1,000
Luminous Efficacy (lm/w)	60	56	63	67
Material	Stainless Steel + Tempered Glass Diffuser + ABS Mounting Sleeve Kit			
Dimension (mm)	Ø1: 52 x H1: 85	Ø1: 62 x H1: 90	Ø1: 110 x H1: 150	Ø1: 150 x H1: 105
Cut Hole Size (mm)	Ø2: 46 x H2: 80	Ø2: 55 x H2: 86	Ø2: 100 x H2: 145	Ø2: 134 x H2: 100
Weight (gm)	160	170	750	800
Ingress Protection (IP)	IP68			
Lifespan (hrs)	50,000			
Driver	External - 24V Non Dimming / Dimming 1-10V			
Driver Part Number	LOMW24V-□□□W			
Input Voltage	24 Vdc			
Driver Ingress Protection (IP)	IP67			

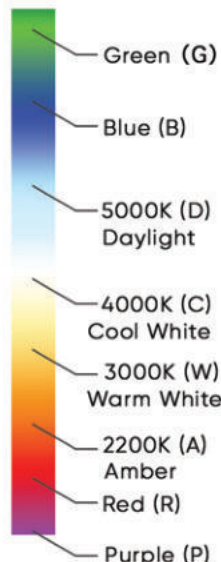
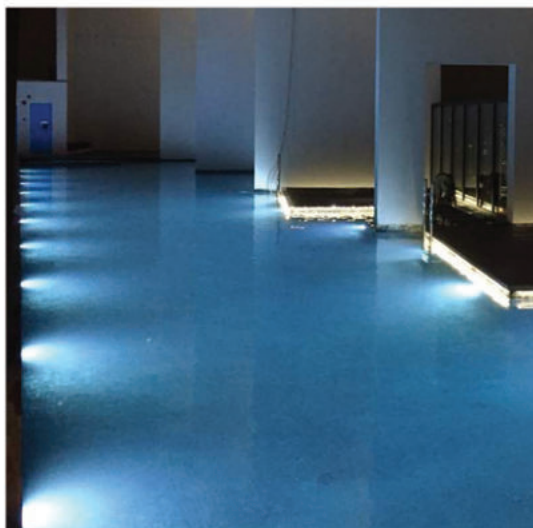

PHOTOMETRIC DATA Luminous Intensity Distribution Diagram

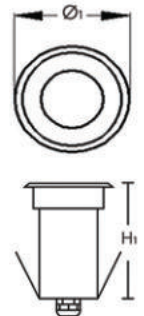
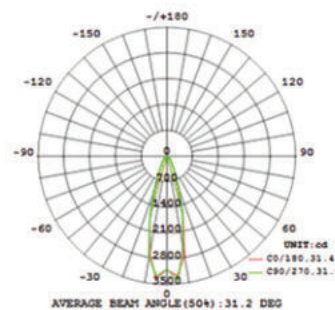

ABS Mounting Sleeve Kit

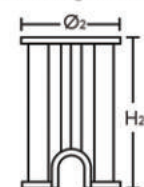

LANDSCAPE LIGHTING

✉ sales@ligled.com.my

☎ +606-3365 696

☎ +6012-345 6789



LIGLED.COM.MY



/LIGLED



MADE IN MALAYSIA



LED INGROUND DRIVE OVER LIGHT (ELEGANT SERIES)

KEY FEATURES

- Can Withstand The Weight Of Vehicles
- Brighten Up Both Driveways & Pathways
- Pressure Capacity Up To 2000 KG
- 1 Way, 2 Way, 3 Way Side Light Output For Option



DESCRIPTION	SPECIFICATION		
Part Number	LINGDO1□SR24E-A02N□□□	LINGDO2□SR24E-A05N□□□	LINGDO4□SRS-A12N□□□
Wattage (W)	2W	5W	12W
Colour Rendering Index (CRI)	85 / 95		
Beam Angle	15° / 25°		
Lumen (lm)	80	200	500
Luminous Efficacy (lm/w)	40	40	46
Material	Aluminium Die Cast + Stainless Steel Cover + Tempered Glass + ABS Mounting Sleeve Kit		
Dimension (mm)	Ø1: 42 x H1: 72	Ø1: 62 x H1: 72	Ø1: 110 x H1: 135
Cut Hole Size (mm)	Ø2: 38 x H2: 72	Ø2: 55 x H2: 86	Ø2: 100 x H2: 135
Weight (gm)	153	266	1004
Ingress Protection (IP)	IP65 / IP67		
Lifespan (hrs)	50,000		
Driver	External - 24V Non Dimming / Dimming 1-10V		Internal - Non Dimming
Driver Part Number	LOMW24V-□□W		ECOPB20
Input Voltage	24 Vdc		220-240Vac (50/60 Hz)
Driver Ingress Protection (IP)	IP67		IP65

LANDSCAPE LIGHTING

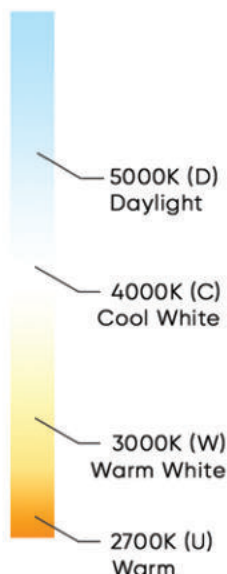

PHOTOMETRIC DATA

Luminous Intensity Distribution Diagram

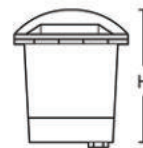
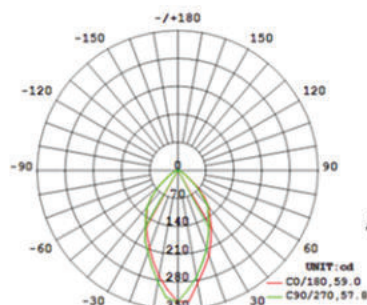

ABS Mounting Sleeve Kit



✉ sales@ligled.com.my

☎ +606-3365 696

☎ +6016-771 5697

LIGLED.COM.MY

/LIGLED

LED INGROUND UPLIGHT ROUND (ELEGANT SERIES)

KEY FEATURES

- High Output Colour
- Suitable For Indoor And Outdoor
- Suitable For In Walk Ways, Drive ways, Paths And Patios
- Exceptional Lighting Performance
- Low Power Consumption
- Energy Saving Up To 60%



DESCRIPTION	SPECIFICATION			
Part Number	LINGUL4RS-A08N□□□□	LINGUL8RS-A12N□□□□	LINGUL10R□-A20N□□□□	LINGUL13R□-A30N□□□□
Wattage (W)	8W	12W	20W	30W
Colour Rendering Index (CRI)	85 / 95			
Beam Angle	15° / 25° / 40° / 60°			
Lumen (lm)	550	860	1,500	2,250
Luminous Efficacy (lm/w)	69	72	75	75
Material	Aluminium Die Cast + Tempered Glass + Stainless Steel Cover + ABS Mounting Sleeve Kit			
Dimension (mm)	Ø1: 120 x H1: 90	Ø1: 210 x H1: 120	Ø1: 260 x H1: 100	Ø1: 320 x H1: 120
Cut Hole Size (mm)	Ø2: 102 x H2: 90	Ø2: 190 x H2: 120	Ø2: 240 x H2: 120	Ø2: 305 x H2: 125
Weight (gm)	1100	2000	2500	3200
Ingress Protection (IP)	IP65 / IP67			
Lifespan (hrs)	50,000			
Driver	Internal - Non Dimming		External - 24V Non Dimming / Dimming 1-10V	
Driver Part Number	ECOPB20		LOMW24V-□□□W	
Input Voltage	220-240Vac (50/60 Hz)		24 Vdc	
Driver Ingress Protection (IP)	IP65		IP67	

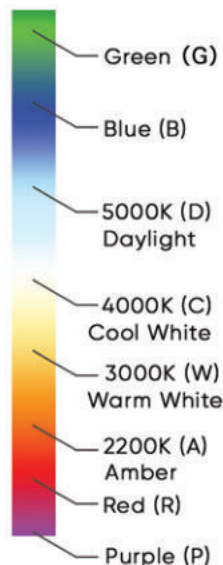

PHOTOMETRIC DATA

Luminous Intensity Distribution Diagram

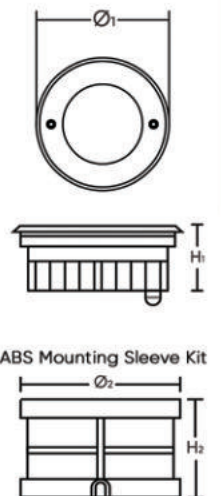
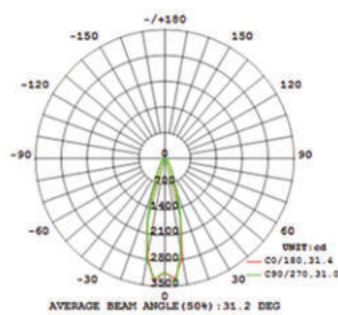

LANDSCAPE LIGHTING

✉ sales@ligled.com.my

☎ +606-3365 696

☎ +6012-345 6789

🌐 LIGLED.COM.MY

📺 /LIGLED



LED INGROUND UPLIGHT LINEAR BATTEN (ELEGANT SERIES)

KEY FEATURES

- Perfect For Architecture
- For Interior & Exterior Light Design Used
- Die Cast Aluminium For Corrosion Resistance
- Strong Tempered Glass

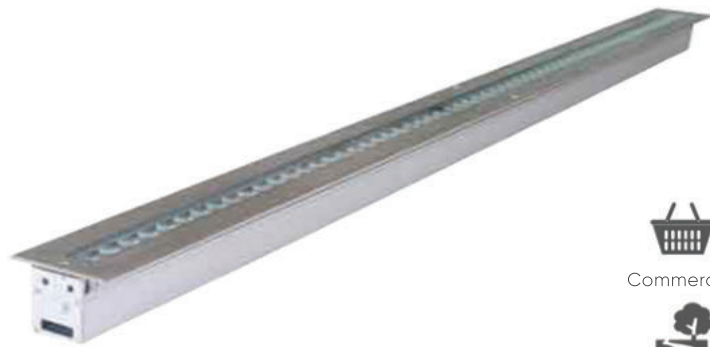

DESCRIPTION	SPECIFICATION	
Part Number	LINGB1MS-A15N□□□□	LINGB15M24E-A50N□□□□
Wattage (W)	15W	50W
Colour Rendering Index (CRI)	85 / 95	
Beam Angle	15° / 25° / 40° / 60°	
Lumen (lm)	1,400	4,500
Luminous Efficacy (lm/w)	93	90
Material	Aluminium Die Cast + Tempered Glass + Stainless Steel Cover + Recessed Kit	
Dimension (mm)	L1: 1050 x W1: 90 x H1: 90	L1: 1620 x W1: 90 x H1: 90
Cut Hole Size (mm)	L2: 1010 x W2: 65 x H2: 90	L2: 1580 x W2: 65 x H2: 90
Weight (gm)	5800	7500
Ingress Protection (IP)	IP65	
Lifespan (hrs)	50,000	
Driver	Internal - Non Dimming	External - 24V Non Dimming / Dimming 1-10V
Driver Part Number	ECOPB20	LOMW24V-□□□W
Input Voltage	220-240Vac (50/60 Hz)	24 Vdc
Driver Ingress Protection (IP)	IP65	IP67

LANDSCAPE LIGHTING

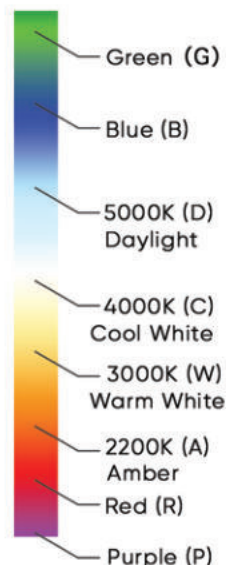

PHOTOMETRIC DATA

Luminous Intensity Distribution Diagram

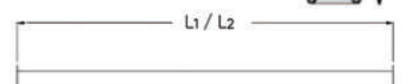
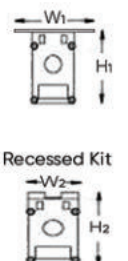
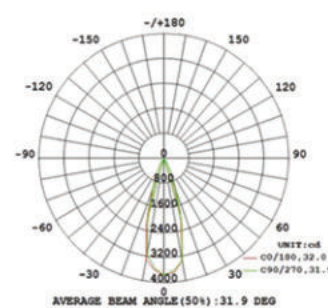

✉ sales@ligled.com.my

☎ +606-3365 696

☎ +6016-771 5697



LIGLED.COM.MY



/LIGLED



FACADE LIGHTING

LED WALL WASHER LIGHT (ELEGANT SERIES)

KEY FEATURES

- Mainly Used With Contemporary Architecture
- For Illumination Of Large Surfaces
- Die Cast Aluminium Housing With Anti-Corrosion



DESCRIPTION	SPECIFICATION				
Part Number	LWW1L1MS-A15NG□	LWW2L1MS-A30NG□	LWW1L1M24E-A20NG□	LWW2L1M24E-A40NG□	LWW2L1M24E-A60NG□
Wattage (W)	15W	30W	20W	40W	60W
Colour Rendering Index (CRI)	85 / 95				
Beam Angle	15° / 25° / 40° / 60°				
Lumen (lm)	1,350	3,000	1,800	3,500	5,000
Luminous Efficacy (lm/w)	90	100	90	88	83
Material	Aluminium Die Cast + Tempered Glass Diffuser				
Dimension (mm)	L: 1000 x W: 35 x H: 24			L: 1000 x W: 42 x H: 28	
Weight (gm)	1600			1800	
Ingress Protection (IP)	IP65				
Lifespan (hrs)	50,000				
Driver	External - Non Dimming			External - 24V Non Dimming / Dimming 1-10V	
Driver Part Number	ECOPB20			LOMW24V-□□W	
Input Voltage	220-240Vac (50/60 Hz)			24 Vdc	
Driver Ingress Protection (IP)	IP65			IP67	



FACADE LIGHTING

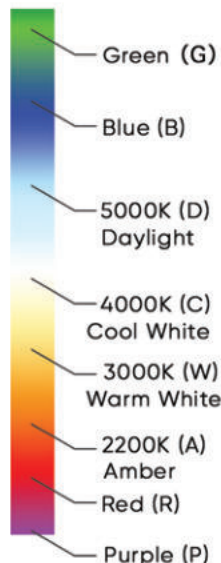

PHOTOMETRIC DATA

Luminous Intensity Distribution Diagram

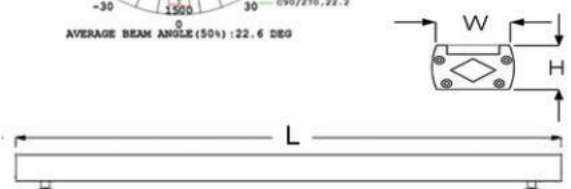
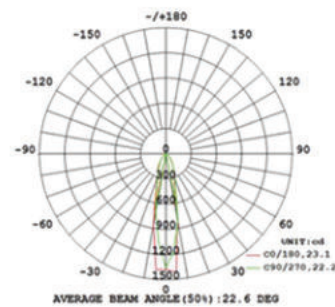

✉ sales@ligled.com.my

☎ +606-3365 696

☎ +6016-771 5697

🌐 LIGLED.COM.MY

📺 [/LIGLED](https://www.facebook.com/LIGLED)



LED RECESSED STEP LIGHT (ELEGANT SERIES)

KEY FEATURES

- Suitable To Light The Pathway, Stair, Step & Corridor
- Very High Uniform Light Output
- Low Maintenance



DESCRIPTION	SPECIFICATION			
Part Number	LRSL01RSS-A05N3P□	LRSL02RSS-A10N3P□	LRSL03RSS-A12N3P□	LRSL05RSS-A20N3P□
Wattage (W)	5W	10W	12W	20W
Colour Rendering Index (CRI)	85 / 95			
Beam Angle	30°			
Lumen (lm)	380	550	800	1,200
Luminous Efficacy (lm/w)	76	55	67	60
Material	Aluminium Die Cast + Tempered Glass Diffuser + ABS Mounting Sleeve Kit			
Dimension (mm)	L1: 145 x W1: 70 x H1: 55	L1: 165 x W1: 100 x H1: 65	L1: 230 x W1: 195 x H1: 100	L1: 320 x W1: 105 x H1: 95
Cut Hole Size (mm)	L2: 142 x W2: 70 x H2: 60	L2: 160 x W2: 95 x H2: 80	L2: 220 x W2: 190 x H2: 110	L2: 295 x W2: 75 x H2: 105
Weight (gm)	150	250	360	300
Ingress Protection (IP)	IP65			
Lifespan (hrs)	50,000			
Driver	Internal - Non Dimming			
Input Voltage	220-240Vac (50/60 Hz)			
Power Factor (PF)	> 0.90			
Total Harmonic Distortion (THD)	< 12%			

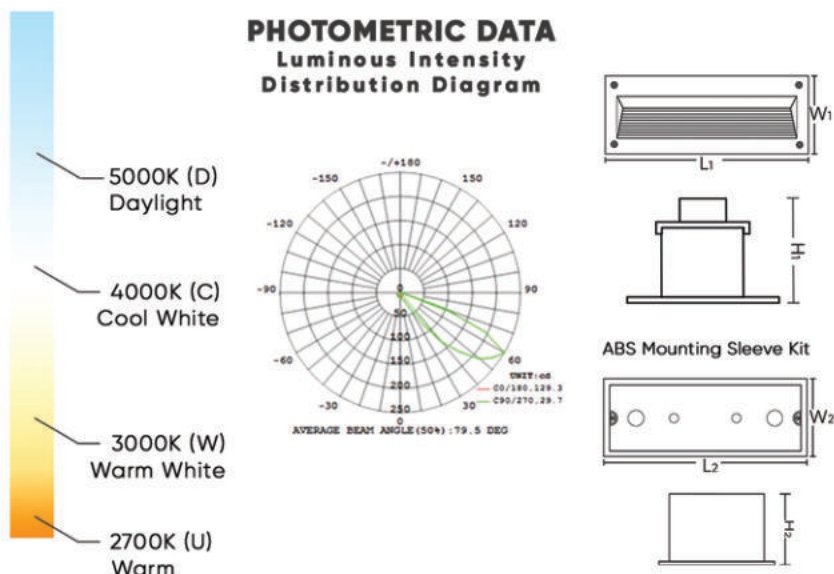
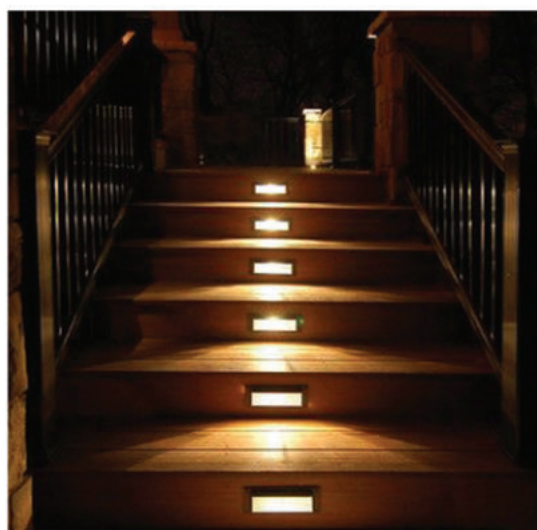

LED SURFACE WALL LIGHT (ELEGANT SERIES)

KEY FEATURES

- Illuminate Facade & Wall Surface
- Uniform High Output
- Symmetrical & Asymmetrical Light Distribution
- Longer Lasting & Low Carbon



DESCRIPTION	SPECIFICATION			
Part Number	LSWL01RSS-A08E3P□	LSWL02RSS-A12N3P□	LSWLD05SS-A12C□□□	LSWLD06SS-A05C□□□
Wattage (W)	8W	12W	2 x 12W	5W
Colour Rendering Index (CRI)	85 / 95			
Beam Angle	30° / 45° / 60°			
Lumen (lm)	380	820	2 x 850	380
Luminous Efficacy (lm/w)	48	68	71	76
Material	Aluminium Die Cast + Tempered Glass Diffuser			
Dimension (mm)	L: 200 x W: 90 x H: 55	L: 200 x W: 120 x H: 60	L: 90 x W: 80 x H: 150	L: 90 x W: 70 x H: 80
Weight (gm)	527	839	945	1449
Ingress Protection (IP)	IP65			
Lifespan (hrs)	50,000			
Driver	Internal - Non Dimming			
Input Voltage	220-240Vac (50/60 Hz)			
Power Factor (PF)	> 0.90			
Total Harmonic Distortion (THD)	< 12%			

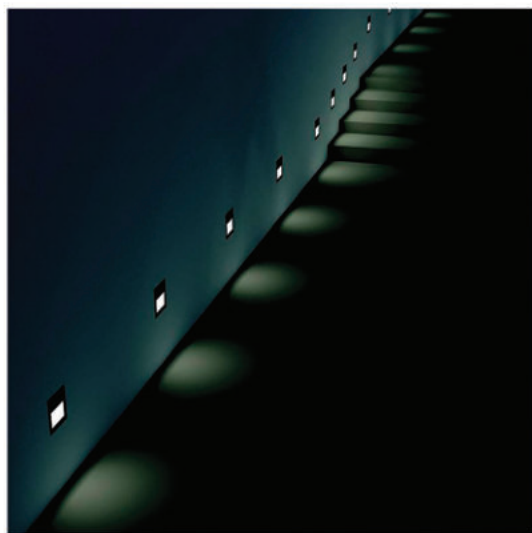

FACADE LIGHTING

PHOTOMETRIC DATA

Luminous Intensity Distribution Diagram

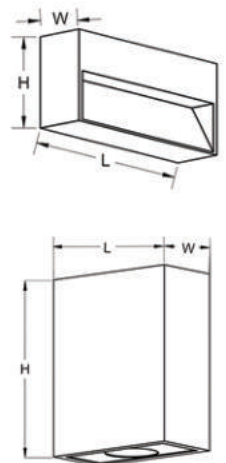
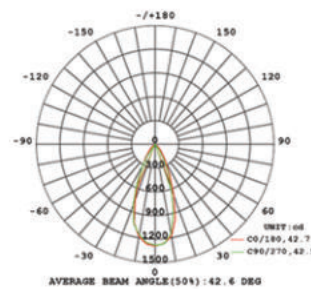
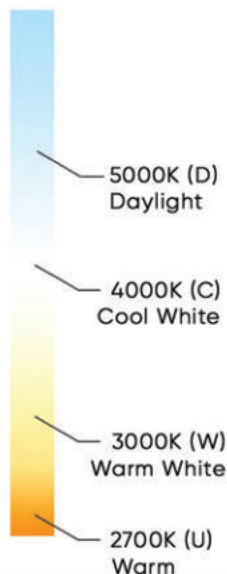

✉ sales@ligled.com.my

☎ +606-3365 696

☎ +6016-771 5697

🌐 LIGLED.COM.MY

📺 /LIGLED



LED SURFACE WALL UPDOWN LIGHT (ELEGANT SERIES)

KEY FEATURES

- Illuminate Facade & Wall Surface
- High Emission Up & Down Side
- Low Emission Carbon Dioxide (CO₂)
- Light Emission At Top & Bottom Side



DESCRIPTION	SPECIFICATION			
Part Number	LSWLUD1RS-A12C□□□□	LSWLUD2RS-A18C□□□□	LSWLUD3RS-A09C□□□□	LSWLUD4RS-A15C□□□□
Wattage (W)	2 x 12W	2 x 18W	2 x 9W	2 x 15W
Colour Rendering Index (CRI)	85 / 95			
Beam Angle	60° / 90°			
Lumen (lm)	2 x 800	2 x 1,300	2 x 680	2 x 1,150
Luminous Efficacy (lm/w)	67	72	76	77
Material	Aluminium Die Cast + Tempered Glass Diffuser			
Dimension (mm)	Ø: 65 x H: 200	Ø: 100 x H: 250	Ø: 90 x H: 260	Ø: 110 x H: 300
Weight (gm)	700	1000	1000	1300
Ingress Protection (IP)	IP65			
Lifespan (hrs)	50,000			
Driver	Internal - Non Dimming			
Input Voltage	220-240Vac (50/60 Hz)			
Power Factor (PF)	> 0.90			
Total Harmonic Distortion (THD)	< 12%			

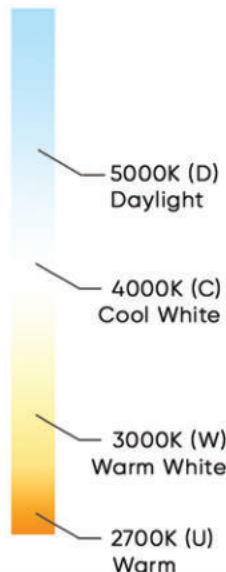
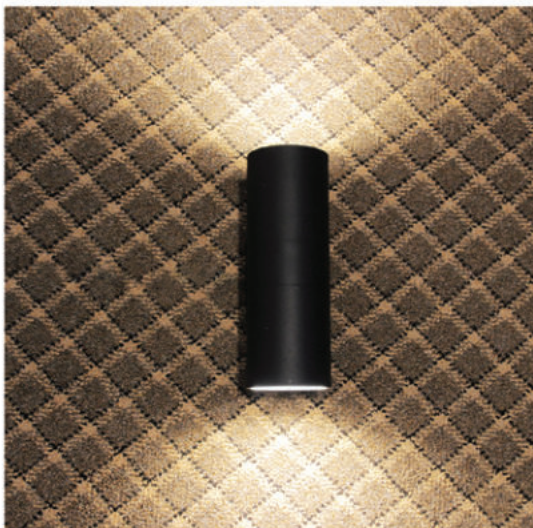

PHOTOMETRIC DATA Luminous Intensity Distribution Diagram

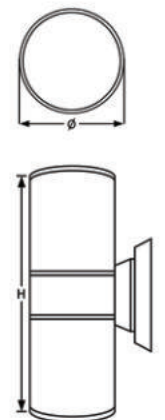
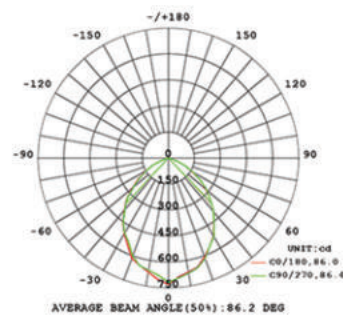

FACADE LIGHTING

✉ sales@ligled.com.my

☎ +606-3365 696

☎ +6016-771 5697



LIGLED.COM.MY



/LIGLED



LED SURFACE WALL DOWNLIGHT (ELEGANT SERIES)

KEY FEATURES

- Symmetrical Light For Used Of Wall Surfaces & Facade
- Very Uniform Light Output
- Light Emission At One Side



DESCRIPTION	SPECIFICATION			
Part Number	LSWLD1RS-A05C□□□□	LSWLD2RS-A12C□□□□	LSWLD3RS-A12C□□□□	LSWLD4RS-A18C□□□□
Wattage (W)	5W	12W	12W	18W
Colour Rendering Index (CRI)	85 / 95			
Beam Angle	60° / 90°			
Lumen (lm)	350	850	850	1,300
Luminous Efficacy (lm/w)	70	71	71	72
Material	Aluminium Die Cast + Tempered Glass Diffuser			
Dimension (mm)	Ø: 65 x H: 120	Ø: 100 x H: 150	Ø: 90 x H: 200	Ø: 110 x H: 200
Weight (gm)	560	650	886	900
Ingress Protection (IP)	IP65			
Lifespan (hrs)	50,000			
Driver	Internal - Non Dimming			
Input Voltage	220-240Vac (50/60 Hz)			
Power Factor (PF)	> 0.90			
Total Harmonic Distortion (THD)	< 12%			

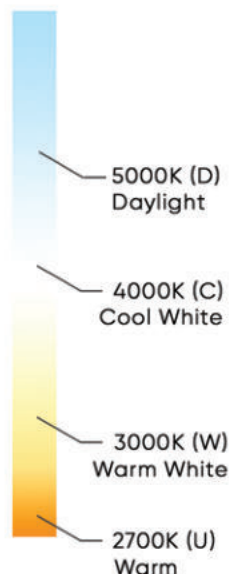
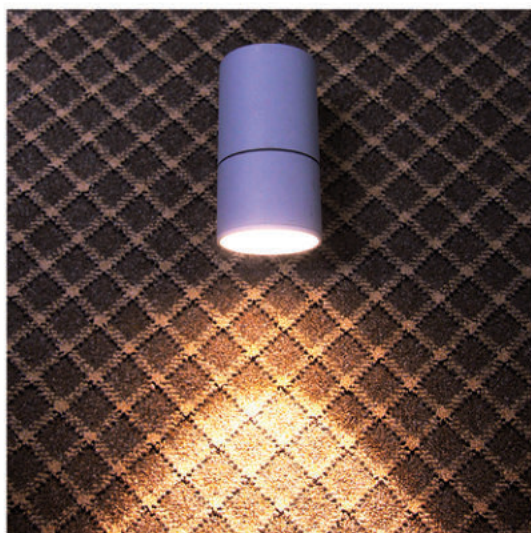

PHOTOMETRIC DATA

Luminous Intensity Distribution Diagram

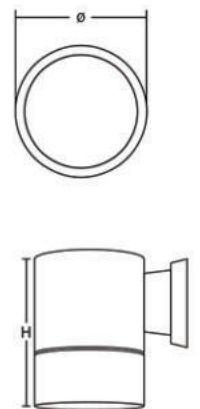
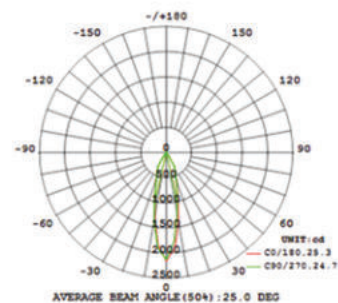

LED FLEXIBLE STRIP (24V SERIES)

KEY FEATURES

- Flexibility Enables To Adjust To Different Shapes, Following Curves And Corners
- Perfect For Cove Lighting, Cabinet Lighting Or Other Indoor Lighting
- Able To Cut The Lighting Strip Each 6 leds
- Super Low Power Consumption With Maximum Brightness



DESCRIPTION	SPECIFICATION	
Part Number	LLS0824E-F08C3C□	LLS1024E-F12C3C□
Wattage (W)	8W / M	12W / M
Colour Rendering Index (CRI)	85 / 95	
Beam Angle	120°	
Lumen (lm)	600	1,000
Luminous Efficacy (lm/w)	75	83
Material	Flexible Strip Tape	
Dimension (mm)	L: 5000 x W: 8	L: 5000 x W: 10
Weight (gm)	160	
Ingress Protection (IP)	IP20	
Lifespan (hrs)	25,000	
Driver	External - 24V Non Dimming / Dimming 1-10V, DALI	
Driver Part Number	LMW24V-□□□W	LOMW24V-□□□W
Input Voltage	24 Vdc	
Driver Ingress Protection (IP)	IP20	IP67

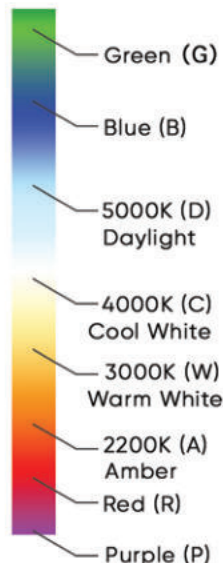

PHOTOMETRIC DATA Luminous Intensity Distribution Diagram

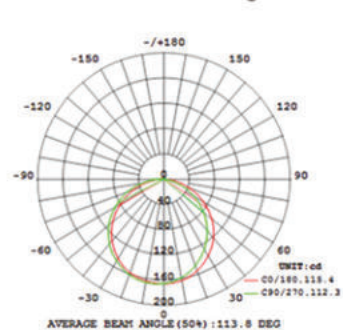

FACADE LIGHTING

✉ sales@ligled.com.my

☎ +606-3365 696

☎ +6016-771 5697



LIGLED.COM.MY



/LIGLED



LED FLEXIBLE SILICONE STRIP CLEAR (ELEGANT SERIES)

KEY FEATURES

- UV & Flame Resistant Construction
- Extremely Flat Profile For Slim Line Projects
- Easy & Low Maintenance
- Interior & Exterior Lighting Decoration
- Vertical Bend (Up & Down)



Facade



Architectural



Outdoor

DESCRIPTION	SPECIFICATION	
Part Number	LFS130624E-S08C3M□	LFS130624E-S12C3M□
Wattage (W)	8W / M	12W / M
Colour Rendering Index (CRI)	85 / 95	
Beam Angle	120°	
Lumen (lm)	450	680
Luminous Efficacy (lm/w)	56	57
Material	Silicon White + Clear Diffuser	
Dimension (mm)	L: 1000 x W: 13 x H: 6	
Weight (gm)	102	
Ingress Protection (IP)	IP65	
Lifespan (hrs)	25,000	
Driver	External - 24V Non Dimming / Dimming 1-10V, DALI	
Driver Part Number	LMW24V-□□□W	LOMW24V-□□□W
Input Voltage	24 Vdc	
Driver Ingress Protection (IP)	IP20	IP67

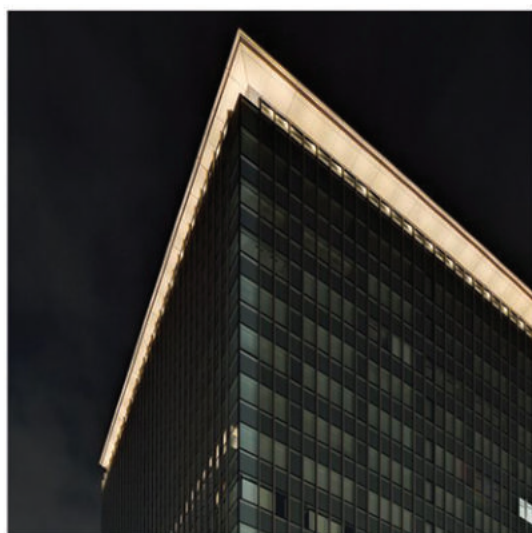

FACADE LIGHTING

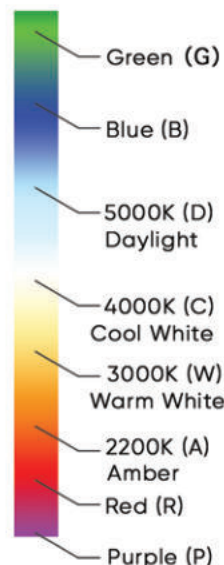

PHOTOMETRIC DATA Luminous Intensity Distribution Diagram

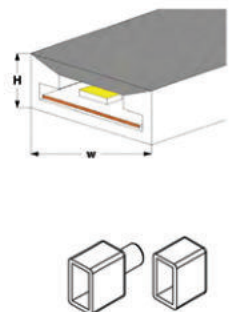
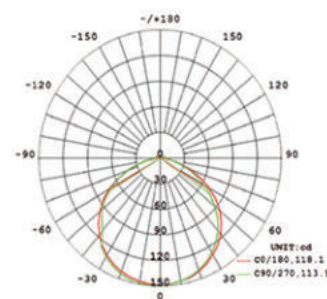

✉ sales@ligled.com.my

☎ +606-3365 696

☎ +6016-771 5697



LIGLED.COM.MY



/LIGLED



LED FLEXIBLE SILICONE STRIP SQUARE (ELEGANT SERIES)

KEY FEATURES

- Good Flexibility And Stylish Appearance, Exquisite And Unique
- UV & Flame Resistant Construction
- Perfect Used For Architectural Lighting
- Vertical Bend (Up & Down)



DESCRIPTION	SPECIFICATION	
Part Number	LFS121224E-S08C3M□	LFS151524E-S12C3M□
Wattage (W)	8W / M	12W / M
Colour Rendering Index (CRI)	85 / 95	
Beam Angle	120°	
Lumen (lm)	320	480
Luminous Efficacy (lm/w)	40	40
Material	Silicone White + Milky Diffuser	
Dimension (mm)	L: 1000 x W: 12 x H: 12	L: 1000 x W: 15 x H: 15
Weight (gm)	217	238
Ingress Protection (IP)	IP65	
Lifespan (hrs)	25,000	
Driver	External - 24V Non Dimming / Dimming 1-10V, DALI	
Driver Part Number	LMW24V-□□□W	LOMW24V-□□□W
Input Voltage	24 Vdc	
Driver Ingress Protection (IP)	IP20	IP67

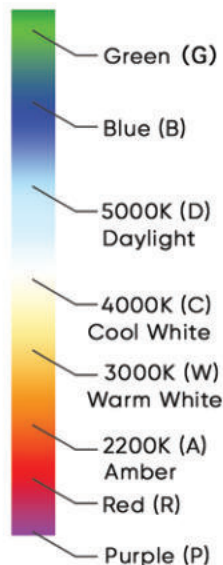
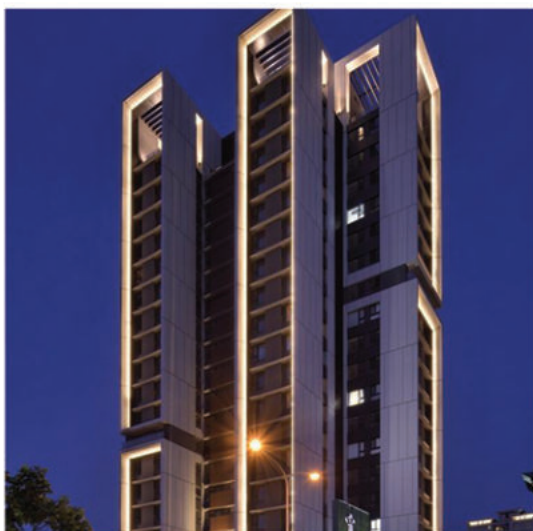

PHOTOMETRIC DATA Luminous Intensity Distribution Diagram

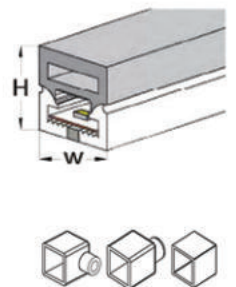
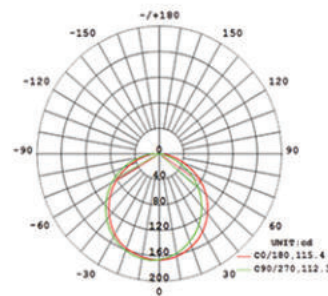

FACADE LIGHTING

✉ sales@ligled.com.my

☎ +606-3365 696

☎ +6016-771 5697



LIGLED.COM.MY



/LIGLED



MADE IN MALAYSIA



RoHS COMPLIANT

LED FLEXIBLE SILICONE STRIP RECTANGULAR (ELEGANT SERIES)

KEY FEATURES

- Good Flexibility And Stylish Appearance, Exquisite And Unique
- UV & Flame Resistant Construction
- Perfect Used For Architectural Lighting
- Horizontal Bend (Left & Right)



DESCRIPTION	SPECIFICATION		
Part Number	LFS061224E-S05C3M□	LFS101824E-S08C3M□	LFS122024E-S12C3M□
Wattage (W)	5W / M	8W / M	12W / M
Colour Rendering Index (CRI)	85 / 95		
Beam Angle	120°		
Lumen (lm)	100	180	250
Luminous Efficacy (lm/w)	20	22	21
Material	Silicone White + Milky Diffuser		
Dimension (mm)	L: 1000 x W: 6 x H: 12	L: 1000 x W: 10 x H: 18	L: 1000 x W: 12 x H: 20
Weight (gm)	173	220	280
Ingress Protection (IP)	IP65		
Lifespan (hrs)	25,000		
Driver	External - 24V Non Dimming / Dimming 1-10V, DALI		
Driver Part Number	LMW24V-□□□W	LOMW24V-□□□W	
Input Voltage	24 Vdc		
Driver Ingress Protection (IP)	IP20	IP67	

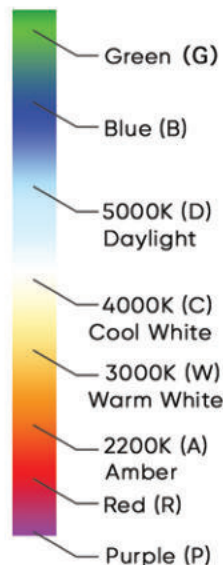
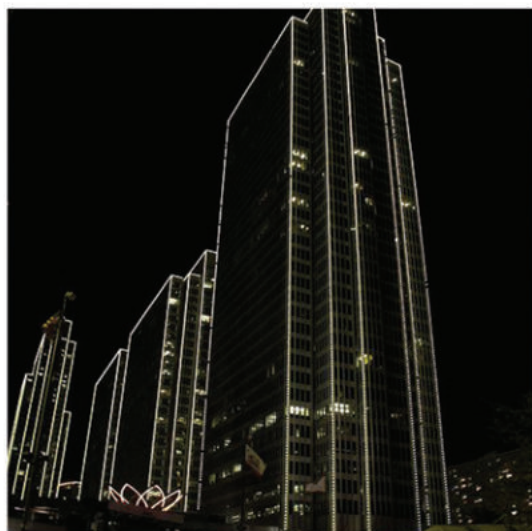

PHOTOMETRIC DATA

Luminous Intensity Distribution Diagram

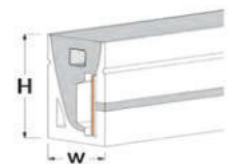
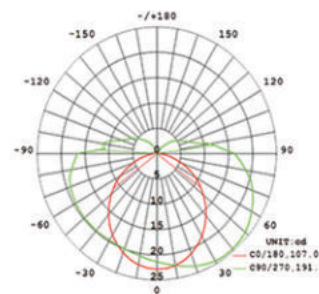

LED FLEXIBLE SILICONE STRIP OVAL (ELEGANT SERIES)

KEY FEATURES

- Good Flexibility And Stylish Appearance, Exquisite And Unique
- UV & Flame Resistant Construction
- Perfect Used For Architectural Lighting
- Horizontal Bend (Left & Right)



DESCRIPTION	SPECIFICATION	
Part Number	LFS102324E-S08C3M□	LFS102324E-S12C3M□
Wattage (W)	8W / M	12W / M
Colour Rendering Index (CRI)	85 / 95	
Beam Angle	120°	
Lumen (lm)	180	250
Luminous Efficacy (lm/w)	23	21
Material	Silicon White + Milky Diffuser	
Dimension (mm)	L: 1000 x W: 10 x H: 23	
Weight (gm)	255	
Ingress Protection (IP)	IP65	
Lifespan (hrs)	25,000	
Driver	External - 24V Non Dimming / Dimming 1-10V, DALI	
Driver Part Number	LMW24V-□□□W	LOMW24V-□□□W
Input Voltage	24 Vdc	
Driver Ingress Protection (IP)	IP20	IP67

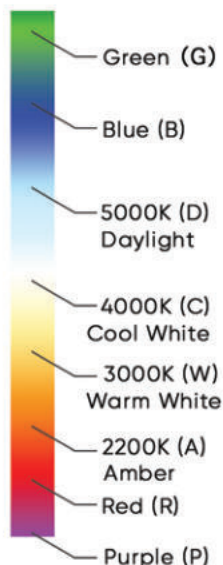
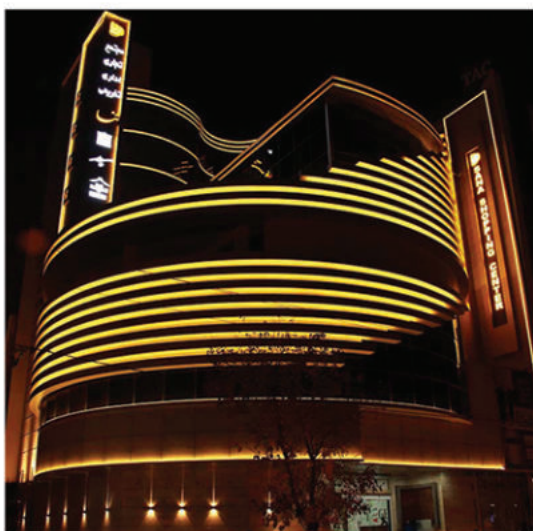

PHOTOMETRIC DATA

Luminous Intensity Distribution Diagram

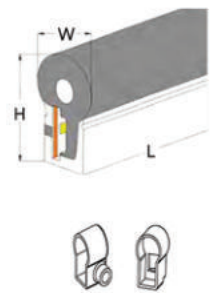
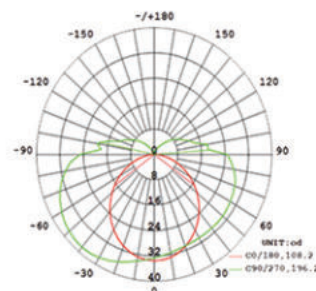

FACADE LIGHTING

✉ sales@ligled.com.my

☎ +606-3365 696

☎ +6016-771 5697



LIGLED.COM.MY



/LIGLED



UVC LED LIGHTING

UVC LED LINEAR BATTEN

KEY FEATURES

- Designed To Be Used In AHU And RTU Air Conditioning Systems
- Kill Up To 99.95% Of Viruses, Bacteria & Fungi
- Reduce Transmission Of Virus Such As SARS, CoV-2
- Disinfect Airborne, and Surfaces That Host Pathogens
- Operates in 24 Hours
- Mercury Free

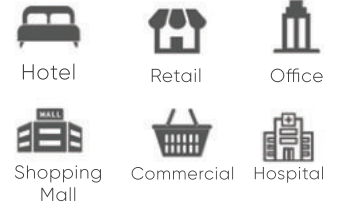

DESCRIPTION	SPECIFICATION							
Part Number	LLB06S-A15N120UVC	LLB06S-A20N120UVC		LLB12S-A30N120UVC		LLB12S-A40N120UVC		
		LLB06S-A15N35UVC	LLB06S-A20N35UVC	LLB12S-A30N35UVC	LLB12S-A30N35UVC	LLB12S-A40N35UVC	LLB12S-A40N35UVC	
Wattage (W)	15W	15W	20W	20W	30W	30W	40W	40W
Beam Angle	120°	35°	120°	35°	120°	35°	120°	35°
Wave Length (nm)	Typ. 275							
Irradiance @ 1 Meter	7.78μW/cm ²	38.10μW/cm ²	11.21μW/cm ²	41.83μW/cm ²	15.56μW/cm ²	76.20μW/cm ²	22.42μW/cm ²	83.66μW/cm ²
Irradiance @ 20 cm	91.38μW/cm ²	326.05μW/cm ²	144.46μW/cm ²	350.25μW/cm ²	182.76μW/cm ²	652.10μW/cm ²	288.92μW/cm ²	700.5μW/cm ²
Material	Body: Aluminium Die Cast + Black Silicon Coating							
Dimension (mm)	L: 600 x W: 35 x H: 50				L: 1200 x W: 35 x H: 50			
Weight (gm)	800				1600			
Ingress Protection (IP)	IP44 /IP65							
Lifespan (hrs) at Ta : 25°C	30,000							
Driver	Internal - Non Dimming							
Input Voltage	220-240Vac (50/60 Hz)							
Input Current	0.064A		0.087A		0.128A		0.174A	
Power Factor (PF)	0.95							
Total Harmonic Distortion (THD)	< 12%							
Operating Temperature °C	- 20°C to + 45°C							

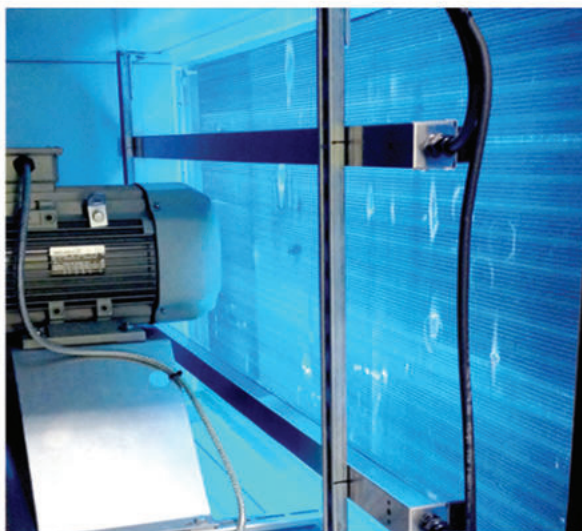

RADIATION DATA

Luminous Intensity Distribution Diagram

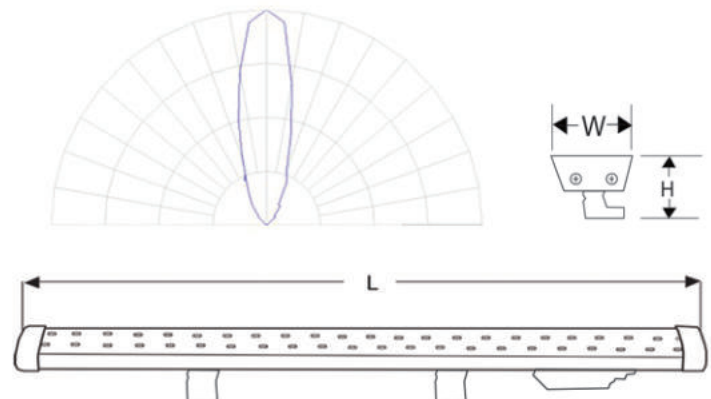

UVC LED STRIP BAR

KEY FEATURES

- Designed To Be Used In HVAC & SCU Supply Air Ceiling Grille
- Kill Up To 99.99% Of Viruses, Bacteria & Fungi
- Reduce Transmission Of Virus Such As SARS, CoV-2
- Disinfect Airborne, and Surfaces That Host Pathogens
- Safe To Operate 24 Hours
- Mercury Free



DESCRIPTION	SPECIFICATION			
Part Number	LSB02SE-A08N125UVC	LSB02SE-A08N35UVC	LSB02SE-A15N125UVC	LSB02SE-A15N35UVC
Wattage (W)	8W	8W	15W	15W
Beam Angle	120°	35°	120°	35°
Wave Length (nm)	Type: 275			
Irradiance @ 1 Meter	4.18 μ W/cm ²	20.06 μ W/cm ²	7.38 μ W/cm ²	38.94 μ W/cm ²
Irradiance @ 20 cm	105.84 μ W/cm ²	315.46 μ W/cm ²	181.85 μ W/cm ²	542.02 μ W/cm ²
Material	Body: Aluminium Bar Profile + Black Silicon Coating			
Dimension (mm)	L: 180 x W: 20 x H: 12		L: 230 x W: 20 x H: 12	
Weight (gm)	50		60	
Ingress Protection (IP)	IP44 / IP65			
Lifespan (hrs) at Ta : 25°C	30,000			
Driver	External - Non Dimming			
Input Voltage	220-240Vac (50/60 Hz)			
Input Current	0.0036A		0.064A	
Power Factor (PF)	0.95			
Total Harmonic Distortion (THD)	< 12%			
Operating Temperature °C	- 20°C to + 45°C			



RADIATION DATA Luminous Intensity Distribution Diagram

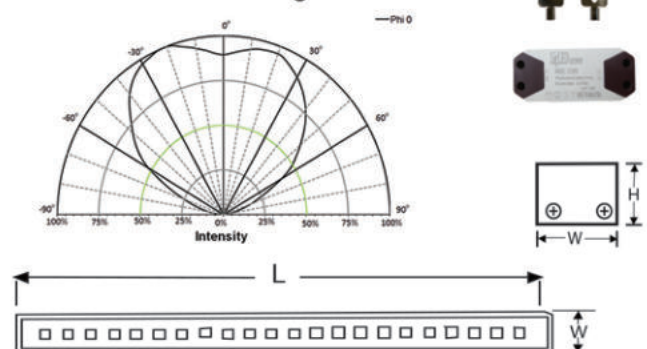

✉ sales@ligled.com.my

☎ +606-3365 696

☎ +6016-771 5697

🌐 LIGLED.COM.MY

📘 /LIGLED



LigLED®

MALAYSIA MANUFACTURER

LigLED® FACTORY

LIGETECH AUTOMATION SDN BHD (524556-H)

No. 60 & 62, Jalan IMJ 2,
Taman Industri Malim Jaya,
75250 Melaka, Malaysia.

Tel: +606-336 5697 /98

Fax: +606-336 5699

sales@ligetech.com.my

www.ligled.com.my

LigLED® SALES & MARKETING OFFICE

I ECO LIGHTING SOLUTION SDN BHD (1089348-A)

(formerly known as SMART GREEN SOLUTIONS SDN BHD)

No. 9-1, Jalan Magenta, Taman Bertam Mutiara,
75250 Melaka, Malaysia.

Tel: +6016-771 5697 /+606-336 5696

sales@ligled.com.my

LigLED® INDONESIA OFFICE

PT LigLED CAHAYA INDONESIA

Komplek Mutiara Taman Palem Blok A19 No.25
Cengkareng - Jakarta Barat, Indonesia.

Tel: +62 21 2901 8880 81

admincahaya@ligled.com.my

 facebook.com/LigLED



Scan to head straight
to our main website!

Distributor / Dealer:

